



Australian Government

Department of the Environment,
Water, Heritage and the Arts
Australian Antarctic Division



ANTARCTIC CLIMATE
& ECOSYSTEMS
COORDINATED RESEARCH CENTRE



WWF



southern
ocean
sentinel

SOUTHERN OCEAN SENTINEL

AN INTERNATIONAL PROGRAM TO ASSESS CLIMATE
CHANGE IMPACTS ON MARINE ECOSYSTEMS



Southern Ocean Sentinel: An International Program To Assess Climate Change Impacts On Marine Ecosystems

© Antarctic Climate and Ecosystems Cooperative Research Centre (ACE CRC), Commonwealth of Australia, WWF-Australia. All rights reserved. 2009

All material appearing in this publication is copyrighted and may be reproduced with permission. Figures and images are copyright to the owners indicated for cases not copyright to this report. In all other cases, any reproduction in full or in part of this publication must credit ACE CRC, Commonwealth of Australia, and WWF as the copyright owners.

The views expressed in this publication are those of the authors and do not necessarily represent the views of ACE CRC, Commonwealth of Australia, or WWF.

Report prepared by: Andrew Constable and Susan Doust. Additional contributions from N. Adams, S. Childerhouse, W. de la Mare, L. Emmerson, N. Johnston, M. Pinkerton, S. Rintoul, C. Southwell, C. Summerhayes, P. Trathan, C. Waluda.

This report should be cited as:

Constable, A.J., Doust, S. (2009) Southern Ocean Sentinel - an international program to assess climate change impacts on marine ecosystems: report of an international Workshop, Hobart, April 2009. ACE CRC, Commonwealth of Australia, and WWF-Australia.

Boxes or appendices written by other authors should be cited as for chapters in edited books.

Acknowledgements

This report is based on presentations, discussions and outcomes of an International Workshop on Monitoring climate change impacts: Establishing a Southern Ocean Sentinel program, held at CCAMLR Headquarters in Hobart, Australia, 20-24 April 2009, hosted by the Antarctic Climate and Ecosystems Cooperative Research Centre, Australian Antarctic Division, and WWF-Australia.

This Workshop, and the preparation and publication of the report, was made possible through the generous support of the Australian Antarctic Division, WWF Australia and the Antarctic Climate and Ecosystems Cooperative Research Centre.

The authors wish to thank the keynote speakers, working group facilitators and all of the participants in the 2009 Workshop, whose expertise and thoughtful input provided the material and outcomes for this report. A full list of participants can be found at the end of the report. Thanks to those who gave support in providing materials and proof reading sections of this report: N. Adams, N. Bindoff, P. Boyd, D. Costa, W. de la Mare, G. Ewing, E. Hofmann, A. Hilkemeijer, K. Hannaford, G. Hosie, N. Johnston, M. Marshal, R. Massom, K. Meiners, M. Meredith, E. Murphy, S. Nicol, P. O'Brien, M. Riddle, S. Rintoul, P. Tracey, P. Trathan, D. Welsford, T. Worby.

We also thank S. O'Rourke, J. Gunn, T. Press, B. Mapstone, R. Nicoll, D. Welsford and G. Llewellyn for their continued support through this process.

We thank the sources of copyright materials for allowing the use of those materials in this report. Details of those permissions are given in the Appendix.

AC was supported in part for this work by a fellowship from the Pew Fellows Program in Marine Conservation.

© 1986 Panda symbol WWF. © [trademark words, e.g. "WWF", "panda", "living planet"] is/are. WWF Registered Trademark/s

ISBN number: 978-1-921031-38-0

For copies of this report contact:

- www.aad.gov.au/sentinel
- www.acecrc.org.au
- www.wwf.org.au/ourwork/oceans/antarctica

Front cover photo credit: Susan Doust

Contents

Acknowledgements	
Executive Summary	2
1 Introduction	4
1.1. This Report	5
2 The Southern Ocean	8
2.1. Ocean Habitats	9
2.2. Sea Ice Habitats	10
2.3. Sea Floor Habitats	10
2.4. Coastal Habitats	11
3 Biota Of The Southern Ocean	19
3.1. Southern Ocean Biota	19
3.2. Life in the Ocean	22
3.3. Food Webs	24
3.4. Ecosystems	25
4 Current Status, Variability and Change	36
4.1. Changing Southern Ocean Ecosystems	36
4.2. Prognoses For Future Ecosystem Changes	38
5 Assessing Climate Change Impacts	46
5.1. Building Plausible Scenarios of Current and Future Impacts	46
5.2. Choosing a Set of Indicators	48
5.3. Designing Monitoring Programs	49
5.4. Attributing Change to Climate Change	49
6 Design and Implementation	52
6.1. Currently Available Strategies to Monitor Change	52
6.2. Developing A Long-Term Assessment Strategy	54
7 Establishing A Southern Ocean Sentinel	57
7.1. A Southern Ocean Sentinel	58
7.2. Next Steps	58
Post Script	61
References	62
Acronyms and Glossary	70
Workshop Keynote Presentations and Working Groups	71
Keynote Speakers	71
Working Group Topics and Convenors	72
Presentations on Benefits of A Southern Ocean Sentinel	72
Workshop Participants	73
Copyright Permissions	74
Appendices	75

Executive Summary

Global greenhouse gas emissions are affecting the Earth's atmosphere, cryosphere, oceans, and terrestrial systems. Future climate change impacts on marine ecosystems are poorly known compared to their terrestrial counterparts. Many climate change impacts on marine ecosystems will be measurable in the Southern Ocean early and least confounded by other future human impacts such as fisheries, pollution and land management. A coordinated international Southern Ocean Sentinel to monitor, assess and signal future climate change impacts on marine ecosystems was considered at an international Workshop on 'Monitoring climate change impacts: establishing a Southern Ocean Sentinel' (hereafter referred to as Workshop) held in Hobart Australia in 2009. This report summarises those discussions and the outcomes.

The Southern Ocean comprises more than 10% of the world's oceans and plays a substantial role in the Earth System. Aside from the Antarctic Circumpolar Current, the defining feature of the region is polar seasonality, which limits most productivity to the spring and summer months. The Southern Ocean represents a complex suite of habitats for its unique biota, defined by light, temperature, water chemistry, depth, and geomorphology, as well as winds, currents, and sea ice. Section 2 outlines how these factors combine to influence biota in ocean, sea ice, coastal and sea floor habitats.

Potential impacts of climate change on the structure and function of Southern Ocean food webs and ecosystems will be dictated, in the first instance, by the sensitivity of organisms to change in the physical environment. The overall dynamics of the system will then be determined by the influence of affected species on other species in the food web, whether that influence is as predators, prey, competitors or in some other role. Organisms benefit from adequate resources to meet their needs, mates for reproduction, and protection from predators. An organism's morphology,

physiology, life history and behaviour will determine the types of habitats in which it can live, as well as how it relates to other organisms. Section 3 introduces the different biota found in the Southern Ocean. It also outlines some of the functional attributes of organisms that will influence where species might be found now and in the future and how successful they will be in those areas. It concludes by considering the general nature of Southern Ocean food webs and the regional differences in the ecosystems.

The Southern Ocean has a heterogeneous suite of ecosystems that are changing. Not all changes will be due to climate change. These ecosystems have been affected over the last two hundred years by over-exploitation of marine mammals and some fish stocks. This has likely resulted in substantial change in the structure and function of the food web, most of which remains undescribed due to the lack of historical data. Changes in the physical environment have been documented, particularly during the era of satellite remote sensing since the late 1970s. Evidence of change from historical data has been increasing over the past decade and also because trends are now becoming more clearly distinguished from natural variability. Section 4 summarises the physical and biological changes observed to date and considers the prognoses for future climate impacts on the physical system.

An assessment of climate change impacts on Southern Ocean ecosystems and biodiversity requires measurements of change in an ecosystem and then attribution of that change to climate change. Field programs need to be designed in such a way that they can discriminate climate change impacts from natural spatial and temporal variation or other causes of change, such as fisheries. The method of attribution will need to be capable of rejecting alternative hypotheses that might explain the observed change. Other ecosystem data may be required for this purpose. Section 5 considers approaches for identifying plausible scenarios of climate change impacts, choosing a set of indicators of those impacts, designing programs to monitor the indicators, and attributing observed changes to climate change.

Antarctic nations have undertaken and sustained large scale scientific endeavours for over 100 years. The International Geophysical Year in 1957-58 bound them into

a collaborative and coordinated effort that remains to this day in the Antarctic Treaty System, an effort exemplified once more in the recent International Polar Year (IPY). Science in Antarctica and the Southern Ocean has played a significant role in resolving difficult and uncertain global issues. Many scientists involved in Southern Ocean research have turned their attention to how much the climate will change, how much Earth's systems will be impacted and how those impacts will affect ecosystems and people. There is an increasing urgency to establish baseline measurements of ecosystem structure and function against which change can be measured. Scientists involved in environmental impact assessments and natural resource management have experience and expertise that could help design programs to support assessments of change and for developing prognoses for ecosystems in the future. Section 6 summarises the strategies that are currently available to monitor change and approaches that could be used in developing a long-term assessment strategy which could optimally facilitate early warning assessments of future climate change impacts on marine ecosystems.

Regional and global policy imperatives need assessments of current and future climate change impacts on Southern Ocean marine ecosystems. A Southern Ocean Sentinel can fill this role. Two important research programs, the Integrating Climate and Ecosystem Dynamics in the Southern Ocean (ICED) of IMBER and the SCAR/SCOR / CLIVAR / CliC's Southern Ocean Observing System (SOOS) are developing, respectively, understanding of climate change impacts on Southern Ocean ecosystems, which will include the development of 'end-to-end' models, and a framework for obtaining the measurements needed to improve our understanding of change in the Southern Ocean. A Southern Ocean Sentinel addresses key objectives of the ICED programme and could, therefore, be most appropriately developed as part of ICED, becoming one of its legacy outcomes. It will also provide the basis for developing key links between ICED and the SOOS program, along with linking other programs and organisations to information on how climate change impacts their activities, such as the Commission for the Conservation of Antarctic Marine Living Resources (CCAMLR) and the Antarctic Treaty Consultative Meeting (ATCM). Section 7 summarises the conclusions of

the Workshop, including the important international climate change questions to which a Southern Ocean Sentinel will contribute and an initial work plan from the Workshop for contributing early warning assessments of climate change impacts on marine ecosystems.

The Workshop agreed that ICED be approached to include the Southern Ocean Sentinel as part of its scientific program. Southern Ocean Sentinel could then be developed as part of the wider community effort to understand the impacts of climate change in Southern Ocean ecosystems. It also suggested that the Southern Ocean Sentinel could be a mechanism for further developing the biological component of monitoring in SOOS and that this should be developed through ICED.

The Workshop agreed that a necessary first step would be delivery of qualitative and preliminary quantitative assessments of climate change impacts on the Southern Ocean to be ready in time for use by the IPCC in its fifth review of climate change. It was suggested that such assessments be undertaken at least for different regions of the Southern Ocean to take account of the regional differences in ecosystem characteristics and climate change impacts.

In conclusion, the wide-ranging and detailed discussions of the Workshop highlighted the existing capacity to undertake assessments of climate change impacts on Southern Ocean marine ecosystems. The Workshop agreed there is an urgent need for developing a long-term monitoring and assessment capability for Southern Ocean ecosystems as a whole. A Southern Ocean Sentinel could be developed as an integrative concept aimed at detecting and assessing early warning signals of climate change impacts on marine ecosystems. The Workshop agreed that this needs to be closely coordinated as part of current and planned Southern Ocean initiatives and that this would most appropriately be achieved by Southern Ocean Sentinel being developed as part of ICED.



1. Introduction

Global greenhouse gas emissions are affecting the Earth's atmosphere, cryosphere, oceans, and terrestrial systems. Future climate change impacts on marine ecosystems are poorly known compared to their terrestrial counterparts. Many climate change impacts on marine ecosystems will be measurable in the Southern Ocean early and least confounded by other human impacts such as fisheries, pollution and land management. A coordinated international Southern Ocean Sentinel program to monitor, assess and signal future climate change impacts on marine ecosystems was considered at an international workshop on 'Monitoring climate change impacts: establishing a Southern Ocean Sentinel' (hereafter referred to as Workshop) held in Hobart Australia in 2009. This report summarises those discussions and the outcomes.

Climate change is impacting on terrestrial and marine ecosystems now and in the future^{5, 6, 11, 25}. The future dynamics of the Antarctic continental ice sheet and Southern Ocean pack ice system will have profound impacts on global oceans and climates^{18, 22}. Current empirical evidence and ocean modelling indicates that the Southern Ocean will be the area impacted sooner than other areas in terms of ocean chemistry and dynamics³. The dynamics of sea ice and near-shore ocean processes also show early signals of the effects of climate change and global warming^{12, 24}. Impacts on marine ecosystems will include changes in ocean processes⁷, carbon cycling¹⁶, and species composition^{5, 13} as well as ecosystem and food web dynamics^{19, 21}.

Research is showing that some empirical indicators of the Southern Ocean, including those from the ocean, sea ice and ice cores, could provide early-warning signals of global climate trends^{14, 15}. Indicators are also being developed for the Northern Hemisphere but these are hampered by a multiplicity of anthropogenic effects, not just climate change.

While links between Southern Ocean signals and global phenomena arising from enhanced greenhouse gas emissions remain to be firmly established⁸, there is no doubt that change in the Southern Ocean will impact on marine ecosystems elsewhere²².

Future impacts of climate change on terrestrial and marine systems are being predicted using a combination of expert views and simulation models^{9, 21}. Much climate-related research to date has focussed on potential shifts in distribution and abundance of biological populations in marine systems driven by temperature⁶. However, recent studies indicate that both abiotic and biotic changes and biological responses in marine environments are significantly more complex. For example, survival or general performance of many organisms may be more affected by changes in ocean chemistry than by changes in temperature, or by disruptions to food web dynamics as a result of impacts on ecological interactions among species^{3, 6}. Empirical data will be needed to unambiguously validate the conclusions from modelling and forecasting studies.

Despite the changes to the ecosystem wrought by historical over-exploitation of whales, seals and fish up to the 1970s, Antarctica and the Southern Ocean is the only region in which signals of the impacts of enhanced greenhouse gas emissions and climate change on ice sheet, sea ice and marine systems can be most readily separated from the effects of other continuing anthropogenic effects, including pollution, industry, coastal zone management (Figure 1.1) and future fisheries (Figure 1.2). A monitoring and assessment program in the region can play an important role in evaluating and estimating the magnitudes and rates of change in global ecosystems. It can be used as a sound means for testing predictions from climate model scenarios of the Intergovernmental Panel on Climate Change (IPCC)^{10, 17, 20} and, thereby, signal future changes in ecosystems. Such a program necessarily will need to be large scale and require an international multidisciplinary research and monitoring effort.

At present, large scale monitoring programs of the type required to provide empirical support to assessing the current and future impacts of climate change on marine biodiversity are poorly developed. An international Workshop on 'Monitoring climate change impacts: establishing a



Southern Ocean Sentinel' was held in Hobart, Australia in April 2009 to consider (i) the state of knowledge of observed and potential climate change impacts on Southern Ocean marine ecosystems, (ii) the scientific and technological research required to establish a Southern Ocean Sentinel, and (iii) the linkages and collaborations among international scientists needed to establish such a program. The Workshop noted that the recent successes of estimating changes consistent with climate change impacts in the physical ocean and ice systems should provide a solid platform for designing a long-term program to estimate change in Southern Ocean ecosystems. Important lessons can be learned from the development of these programs in the last 30 years or more, such as the development and success of the World Ocean Circulation Experiment²³.



1.1. This Report

This report, which is based on the discussions and outcomes of the Workshop, provides the rationale and work program for the further development of a Southern Ocean Sentinel. Sections 2 and 3 provide a summary of the physical and biological attributes of Southern Ocean ecosystems, while Section 4 summarises the variability and changes that have already been observed in the system and highlights the current prognoses for future climate change impacts in the region. The remaining sections provide background on approaches to undertaking an assessment of current and future climate change impacts on Southern Ocean ecosystems including theoretical considerations for developing an assessment procedure (Section 5) and practical considerations for the design and implementation of a Southern Ocean Sentinel as an integrated, coordinated, multi-disciplinary and international effort (Section 6), including examples of existing national and international programs that could add capacity and value to the program. Section 7 highlights the conclusions of the workshop on a process and workplan for developing a Southern Ocean Sentinel, incorporating it as a project within the international program for Integrating Climate and Ecosystem Dynamics (ICED) in the Southern Ocean and providing support to the biological monitoring in the Southern Ocean Observing System (SOOS).

1.2. Figures

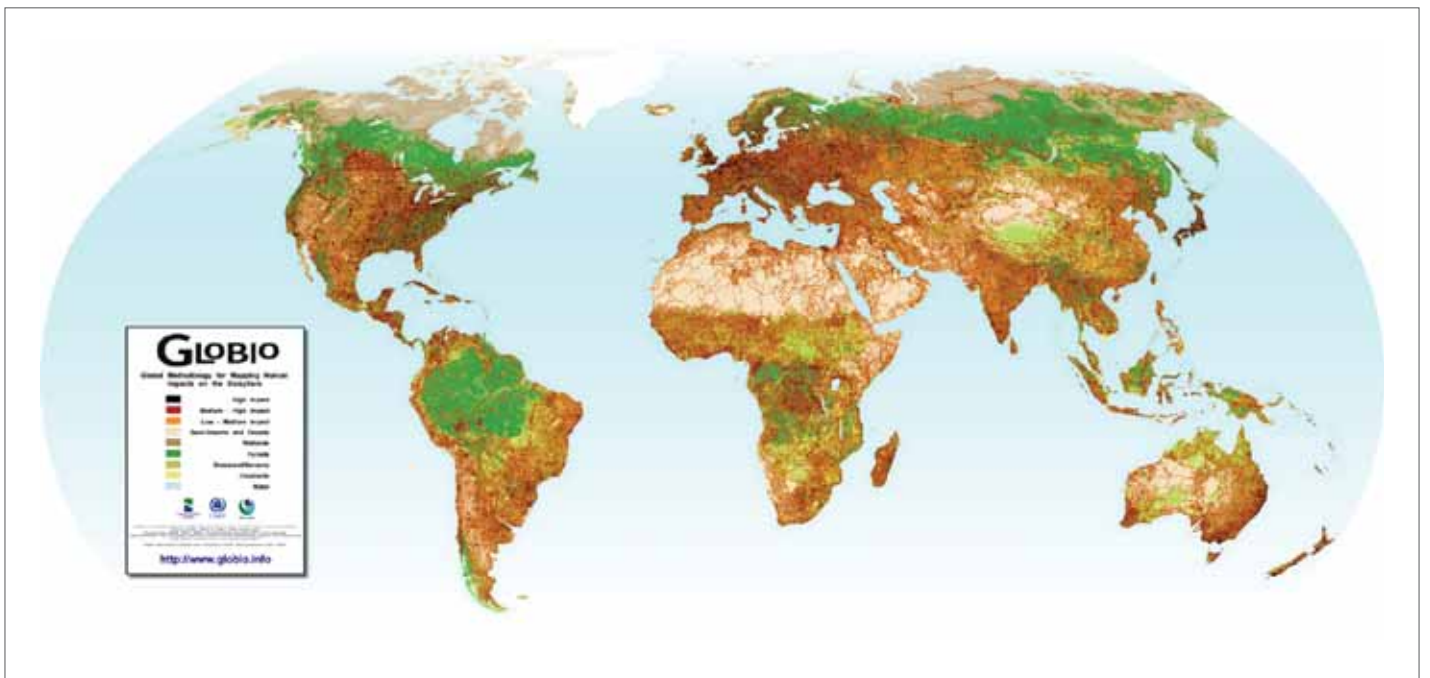

Figure 1.1. Map of human impacts on the biosphere for 2002 using the GLOBIO-2 model, which is based on settlements and modern infrastructure such as roads, powerlines and pipelines. (Source: UNEP/GRID-Arendal, Human impact, year 2002, UNEP/GRID-Arendal Maps and Graphics Library, <http://maps.grida.no/go/graphic/human-impact-year-2002>. 6 October 2009)
Note: orange/brown = low-medium impact, red = medium-high impact, black = high impact.

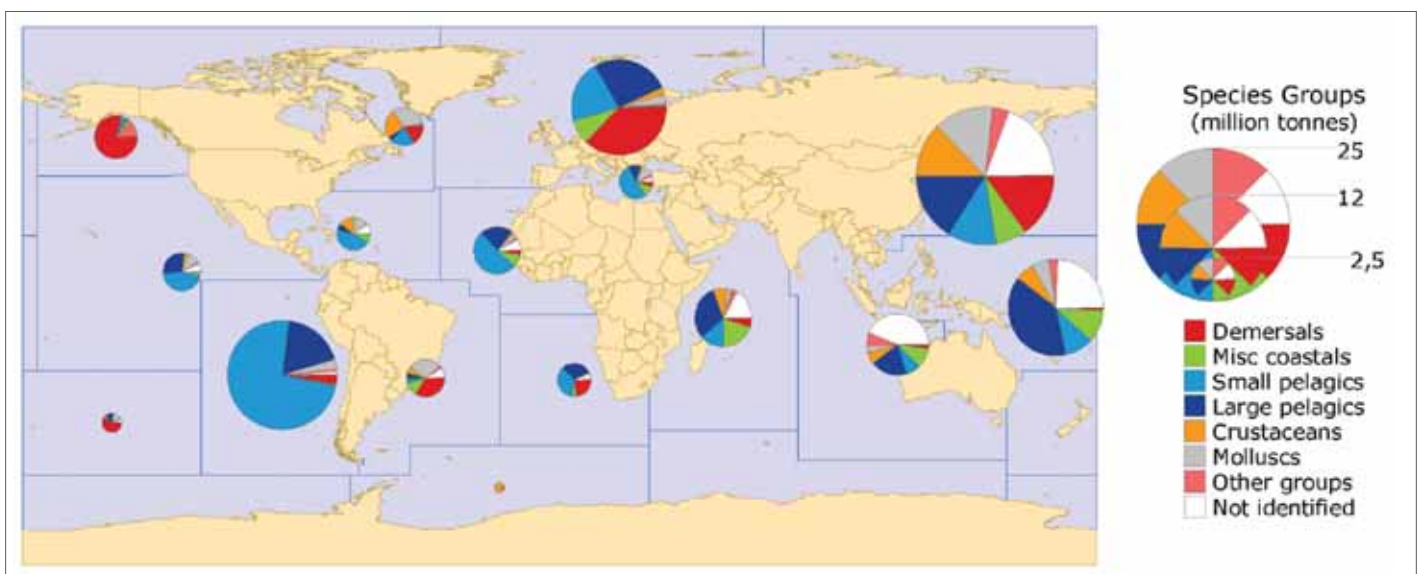

Figure 1.2. World marine catches, main species groups by major marine fishing areas in 2002. Source: FAO, Rome 4.
Note: current catch for Antarctic krill is less than 2.5% of the total allowable catch set in the CCAMLR ^{1,2}.





2. The Southern Ocean

The Southern Ocean comprises more than 10% of the world's oceans and plays a substantial role in the Earth System. Aside from the Antarctic Circumpolar Current, the defining feature of the region is polar seasonality, which limits most productivity to the spring and summer months. The Southern Ocean represents a complex suite of habitats for its unique biota, defined by light, temperature, water chemistry, depth, and geomorphology, as well as winds, currents, and sea ice. This section outlines how these factors combine to influence biota in ocean, sea ice, coastal and sea floor habitats.

The Southern Ocean covers almost 50 million square kilometres and uniquely joins all the major oceans of the world through the uninterrupted eastward flow of the Antarctic Circumpolar Current (ACC). The physical dynamics of the region are driven by wind (Box 2.1.; Figures 2.1-2.4) and sea ice. It is bounded to the north by the Subtropical Front, although its major characteristics are found south of the Subantarctic Front (Figure 2.5)²⁴. It makes a substantial contribution to the regulation of global climate through heat transfer from the atmosphere to the ocean as well as the sequestration of atmospheric carbon in its colder waters. Global ocean circulation is primarily driven from the Southern Ocean through bottom water formation along the coast of Antarctica, transporting its nutrient-rich water throughout the global oceans via thermohaline circulation (Ocean Conveyor Belt)¹⁴.

For biota, the Southern Ocean represents a complex suite of habitats defined by light, temperature, water chemistry, depth, and geomorphology, as well as winds, currents, and sea ice (Figure 2.6). The latter three factors not only directly influence biota but can also cause spatial and temporal variation in the physical characteristics of marine habitats. The defining feature of the region is polar seasonality, which truncates the period of greatest productivity to the spring and summer months⁵ and drives key biological processes⁷.

2.1. Ocean Habitats

Most of the biological activity in the Southern Ocean occurs in the top 300 m where light[†] and nutrients combined are at their maximum. This is often referred to as the ‘mixed layer’ as the water is well mixed due to the prevailing winds stirring up the surface of the ocean. The depth of the mixed layer can be as shallow as 50 metres in summer due to weaker winds combined with a shallow stratification of the water column (resulting from sea ice melt in spring and the warming of the surface waters in summer)¹³.

Vertical mixing entrains deep nutrient-rich water to the surface as well as keeping otherwise sinking phytoplankton in the light (photic) zone. The degree of mixing is determined by wind stress and the buoyancy[‡] of the water. Transformation of the buoyancy of water occurs through heat exchange with the atmosphere (warmer water is more buoyant) or changes in salinity (less saline water is more buoyant).

The ACC (also known as the West Wind Drift owing to strong westerlies in the region) flows uninterrupted around Antarctica (Figure 2.5) and takes approximately six years to complete a circumnavigation (but this shows significant variability due to variation in atmospheric conditions^{11,18}). The ACC is compressed as it passes through the Drake Passage bounded by the Antarctic Peninsula to the south and South America to the north. It is also spread and partitioned as it passes over and around the Kerguelen Plateau in the southern Indian Ocean, which is the second largest submarine plateau in the world. It is then guided to the south by the passages through the Macquarie Ridge and the Campbell Plateau to the south of New Zealand.

The ACC is divided into a number of fronts (Figure 2.7)^{22,25}, each of which can be identified by a rapid change in surface thermohaline (temperature and salinity) properties. These fronts are higher velocity flows than elsewhere in the ACC and have been found to influence the assemblages of different plankton species across the Southern

Ocean. Importantly, large numbers of complex eddies are formed by the transfer of kinetic energy from the strong winds to the ocean. Such eddies are likely to be very important to many mobile biota in the region²⁶. Near to the Antarctic continent is a smaller coastal countercurrent (East Wind Drift) with a number of clockwise gyres, most notable of which are the large Ross Sea and Weddel Sea gyres. These are driven by the easterlies and the katabatic winds blowing off ice sheets. Here, the major frontal jet is the Antarctic Slope Front.

The global thermohaline circulation (Figure 2.8)²⁴ plays a major role in maintaining the productive surface waters of the Southern Ocean as well as driving the carbon pump, which comprises biological and solubility pumps that drive the exchange of carbon dioxide with the atmosphere (Figure 2.9)⁴. Ekman transport moves water from the higher latitudes near the Antarctic continent to the north and to the south. This creates a “window to the deep sea” where nutrient-rich deep water comes to the surface, releasing carbon dioxide and other gases. The water moving south is cooled in polynyas (large recurrent areas of open water/thin ice) or below ice shelves and enriched with salt from sea ice formation, making it very dense. The dense water sinks, flowing down the Antarctic continental margin to form Antarctic Bottom Water (AABW). AABW is predominantly formed in the Weddell and Ross Seas but also can be significant in other shelf locations²⁸.

The surface water moving northward becomes warmer, removing heat from the atmosphere. Evaporation also occurs resulting in more saline and dense sea water. With increasing density, along with oxygen and carbon, this water eventually sinks to the north of the Subantarctic Front to form the Antarctic Intermediate Water and flows beneath the subtropical gyre to surface near the equator. The different water bodies can be mapped in the ocean because they have a characteristic signature of temperature and salinity at depth.

These ocean dynamics create a variability in space and time that influence the distribution and abundance of primary production and zooplankton assemblages^{7,10,19}. Importantly, these processes will determine the availability of nutrients in the surface waters and the import and export of material and plankton both vertically and between locations in the Southern Ocean.

Primary production is limited by light and nutrients. Ocean stratification helps keep phytoplankton near to the surface in the light zone but can limit primary production if nutrients, particularly iron, are available in the surface layer. Temperature is the most common form of stratification, where the surface of the ocean is warmed, making it buoyant, and isolated from the cooler deeper ocean (the boundary is known as a thermocline). In the spring another layer of lower salinity forms as a result of melting of sea ice, the depth of which varies depending on wind-driven turbulence. This turbulence also helps keep negatively buoyant material and plankton in the surface waters longer as well as replenishing those waters with nutrients from below.

The Southern Ocean is known as a high nutrient – low chlorophyll (HNLC) ocean, meaning that nitrogen and phosphorous do not limit primary production¹³. In this case, iron is thought to be the primary micro-nutrient limiting production¹⁵. The areas where iron is not limiting are evident from satellite images of the distribution of Chlorophyll *a* showing regions of high productivity (Figure 2.10).

[†] The depth of the euphotic zone in clear water is approximately 200 m where there is sufficient light intensity for primary production to occur.

[‡] Buoyancy is governed by the density of the water which, in turn, is determined by a combination of temperature and salinity. Lower temperatures and higher salinities respectively increase the density of water.



2.2. Sea Ice Habitats

Sea ice is a habitat that profoundly alters the Southern Ocean each year through its expansion over approximately 40% of the region (19 million km²) in autumn and winter followed by its melting in spring and early summer (Figure 2.11). The sea ice habitat, however, does not simply advance and retreat, it is a dynamic environment affected by underlying ocean currents, overlying winds, precipitation and light regimes²¹.

Sea ice reflects light (and heat) back into the atmosphere (albedo effect), substantially reducing the amount of light available to organisms in the water column. It also limits both the warming of surface waters and wind-driven mixing of the surface layer. Sea ice is a highly fragmented habitat, forming floes, rafting, melting and refreezing. Figure 2.12 shows the different zones or habitats of sea ice. Most importantly, a sea ice floe will move as a result of the currents and winds, thereby acting as a transport vector for the biota that live in association with the sea ice (Figure 2.13). Where the sea ice breaks up, waves can cause flooding of the surface environment, which may then refreeze, changing the available habitat by diminishing the porosity

of the ice. Snow fall on the surface of the sea ice significantly diminishes the light that penetrates through the ice. While this will impede primary productivity in the sea ice habitat, it will also increase the reflectivity of the sea ice.

As the sea ice habitat forms it retains remnants of phytoplankton production. These algae are captured within brine channels or attached to the under-surface of the sea ice²⁷. This provides a suitable habitat for overwintering juvenile Antarctic krill²⁰. As the sea ice melts in the following season, ice algae are released into the surface water providing a strong foundation for the ensuing spring phytoplankton bloom (Figure 2.14). The meltwater creates a buoyant fresher water stratum on the sea surface. This stratification helps prevent the phytoplankton cells from sinking below the light zone. Sea ice is also thought to assist in capturing and accumulating iron, which is accumulated in the sea ice by various processes during winter and then released into the water during ice melt in spring, thereby providing essential micronutrients to the algae¹².

2.3. Sea Floor Habitats

Habitats of the ocean floor are governed by water depth, geomorphology, which is determined by sea floor type (hard versus soft), local rates of sediment deposition (coarse sands to fine mud), scouring by icebergs (down to 500m) and currents (Figure 2.15). These features can be separated into coastal margins, the continental shelf and slope, and the wider ocean basins.

On the continental shelf, the sea floor comprises shelf areas, banks, depressions, cross-shelf valleys and areas covered by ice shelves known as ice shelf cavities. Particulates and detritus must be advected into the latter areas if organisms are to survive there. The continental slope includes features such as the shelf break at the top of the slope, lower slope, canyons cutting across the slope, trough mouth fans of finer sediment, and marginal extensions of the slope that could include ridges and small plateaux.

The wider ocean basins comprise large abyssal sediment plain punctuated by a number of features including contourite drifts (mounds of fine sediment built by ocean currents), rugose (rough and craggy) reefs on the ocean floor, seamounts and seamount ridges rising 1000m or more above the sea floor, mid-ocean ridge rift



© Susan Doust

2.4. Coastal Habitats

valleys, cliffs, and ocean troughs and trenches. Plateaux, such as the Kerguelen Plateau, and islands, including volcanos, can also form part of the wider ocean basins, notably in the subantarctic. In all areas, the seafloor can be affected by waves with wave abrasion occurring down to 70m and the sorting of sediments occurring down to 200m.

Productivity of the sea floor habitats depends primarily on the rates of sedimentation of organic material exported from overlying productive waters, as well as the chemistry of the water passing over the sea floor. For many organisms that have calcium carbonate (calcite or aragonite) shells or skeletons, the depth of water (denoted the lysocline) is important because above the lysocline the water is supersaturated with calcite or aragonite. Below it, the dissolution of calcite increases dramatically. Notably, acidification of the ocean will lead to the lysocline becoming shallower, raising concerns for the health of deep sea corals and other benthic invertebrates⁹.

Habitats on the continental margins may experience this effect first. This is because of the sinking of surface water as Antarctic Bottom Water, which may carry higher concentrations of carbon dioxide (Figure 2.8).

Antarctic coastal habitats vary spatially and temporally (Figure 2.16). The Antarctic coastline is a combination of rocky outcrops, fast ice permanently attached to the coast, tongues of glaciers protruding into the ocean and large ice shelves. The latter are extensions of the continental ice sheet over the ocean and make up approximately 44% of the coastline.

Coastal polynyas and fast ice occur all around the Antarctic continent. Fast ice is a relatively stable habitat of algal growth, and is crucial breeding platform for emperor penguins and Weddell seals. ‘Latent heat’ polynyas usually have a similar location and extent from year to year and constitute major regional sea ice ‘factories’, sites of major water-mass modification³ and, in places, regions of enhanced biological activity.^{1a} As previously mentioned, AABW formed in these polynyas carry productivity and water chemistry to the deep shelf and slope areas, where they contribute to productivity of deep sea floor habitats² (Figure 2.17).

The marine environment immediately adjacent to the coast is influenced by icebergs calved from the ice shelves, the topography of the

sea floor, the strength of the katabatic winds blowing off the continent, and the offshore winds and currents. For example, icebergs are moved by the winds but can become grounded on the shallow bank areas. These areas become scoured and tend to be inhabited by species that are quick to colonise new areas exposed by this scouring.

“acidification of the ocean will lead to the lysocline becoming shallower, raising concerns for the health of deep sea corals and other benthic invertebrates⁹”

Box 2.1. Winds In The Southern Ocean And The Southern Annular Mode (SAM)

By Neil Adams, Australian Bureau of Meteorology, Hobart, Australia.

The atmosphere over the Southern Ocean, in the mid to high latitudes, is dominated by low pressure systems circling the hemisphere. These systems give rise to strong westerly winds in the mid-latitudes to their north and easterlies in the high latitudes to their south (Figure 2.1). The winds over the Southern Ocean in response to the low pressure band are shown for a region south of Australia in Figure 2.2. As can be seen in this snapshot there is a reasonable degree of meridional flow evident. There is also a strong south to south-easterly flow off the Antarctic coast immediately south of Tasmania in response to both a deep low pressure system and the katabatic outflow. Strong flow is generally in response to the active low pressure systems.

Figure 2.3 shows the mean surface level pressure for September of 2009. For this month the higher latitudes were dominated by three areas of low pressure, with one centre to the north of Casey, a second around the Siple Coast and the third to the west of Enderby Land. A broad area of westerly flow is evident to the north of the polar trough and easterlies to the south. This shows that, in the mean, the flow is not as strong, nor as meridional as in the snapshot image in Figure 2.1. The broad scale mean flow is driven by faster moving and more intense transient systems. While surface mixing and wave action will be influenced by each pressure system, the overall current velocities will be responding more to the means over longer time scales.

The Southern Annular Mode (SAM) index is a measure of the strength of the westerly band found around the hemisphere to the north of the polar trough. The SAM index has been increasing over the last few decades as a result of strengthening westerly flow from deepening low pressure systems in the polar trough, along with a shift of the westerly flow further south. The magnitude for the SAM is expected to increase with sea level pressure projected to rise over the sub-tropics and mid-latitudes and decrease over high latitudes (Figure 2.4)¹⁷. This trend into the end of the twenty first century is expected as a continuation of what has been seen over the last few decades.

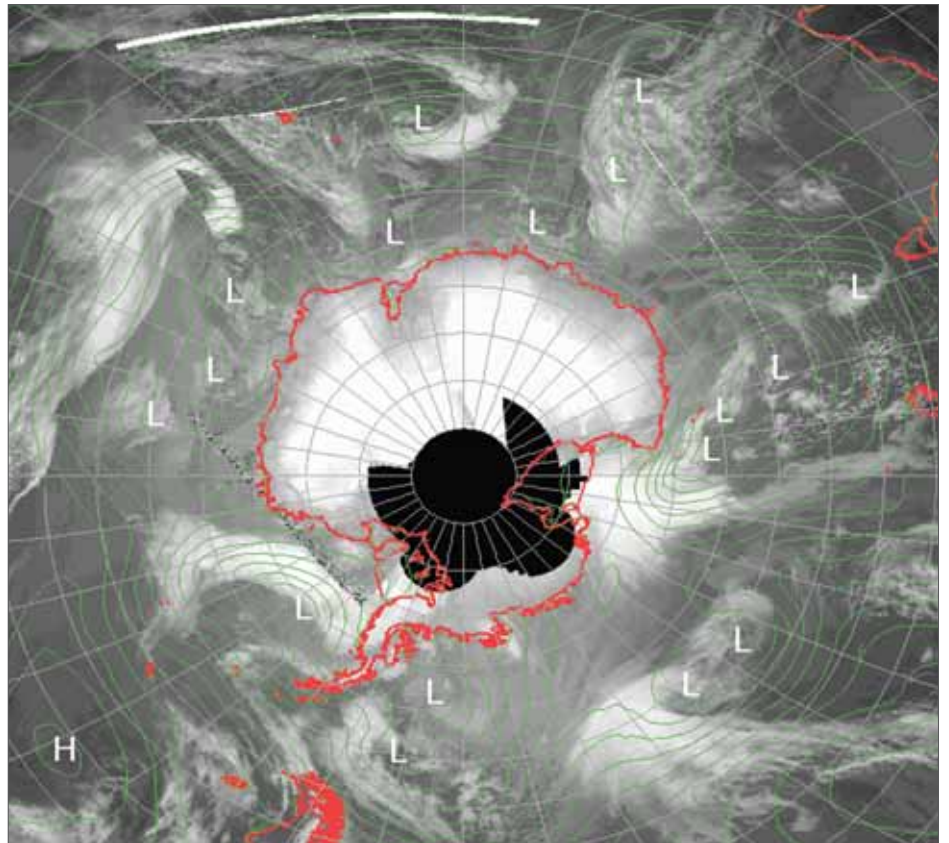

Figure 2.1. A snapshot of the Southern Hemisphere weather taken at 0000 UTC on 2 October 2009. The satellite image is a composite of geo-stationary and polar-orbiting data with the surface level pressure field (green contours) taken from the +12 hour forecast of the polarLAPS system (polar stereographic version of the Limited Area Prediction System,¹). (H)igh and (L)ow pressure systems around the hemisphere are labelled in white. Coastlines are in red.

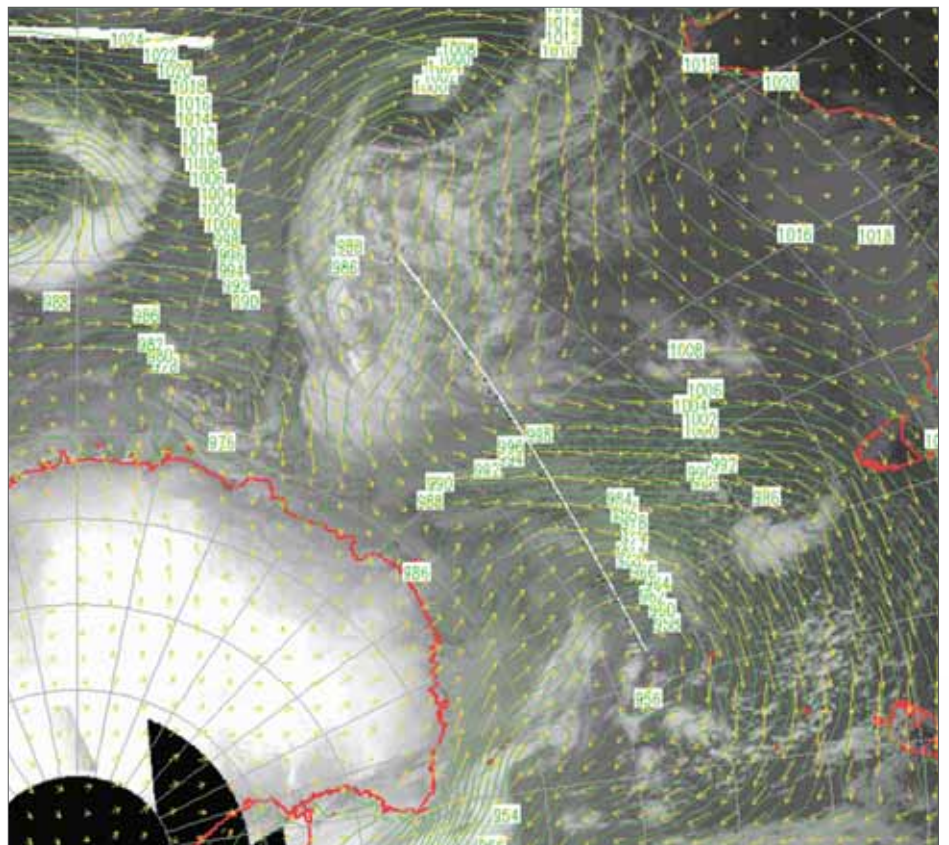

Figure 2.2. Wind vectors in response to low pressure systems shown in Figure 2.1 but highlighting high southern latitudes to the immediate south of Australia. Near surface (9 m) wind vectors plotted in yellow. Labels are hPa of the isobars.

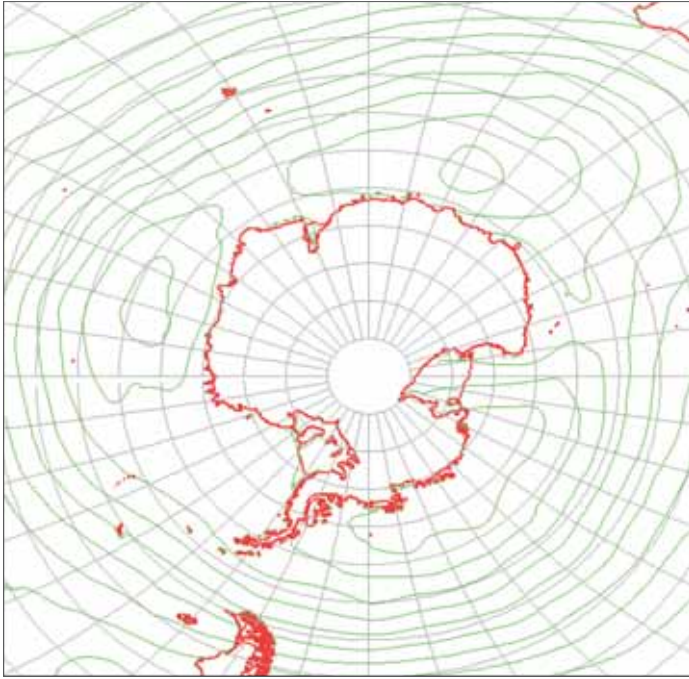

Figure 2.3. Monthly mean surface level pressure for September 2009 from the polarLAPS system, displayed over an identical domain to Figure 2.1.

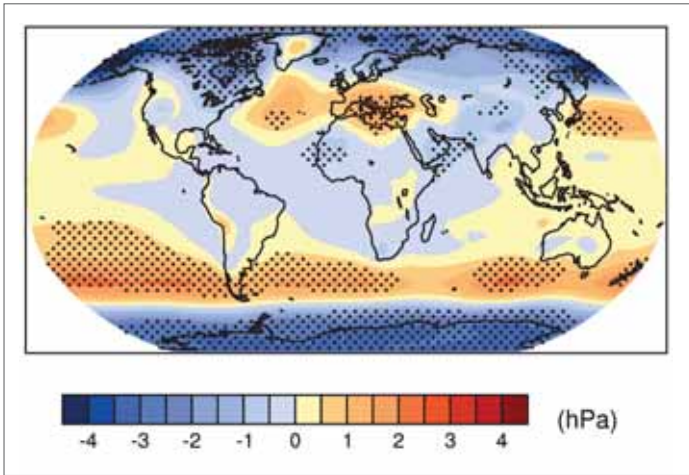
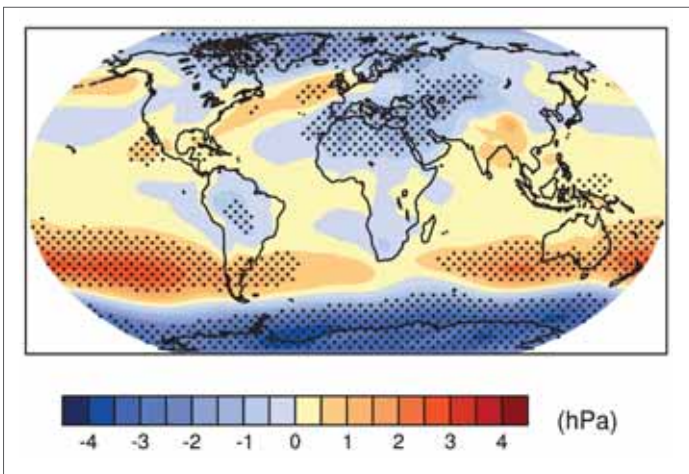

Figure 2.4. A subset of Figure 10.9 from Chapter 10 of the IPCC AR4 report¹⁷, showing the multi-model mean changes in surface level pressure for the austral summer (December-February, top) and austral winter (June-August, bottom). Changes are given for the SRES A1B scenario, for the period 2080 to 2099 relative to 1980 to 1999. Stippling denotes areas where the magnitude of the multi-model ensemble mean exceeds the inter-model standard deviation.



2.6. Figures

Figure 2.5. Major physical features and ocean fronts²² in the Southern Ocean.

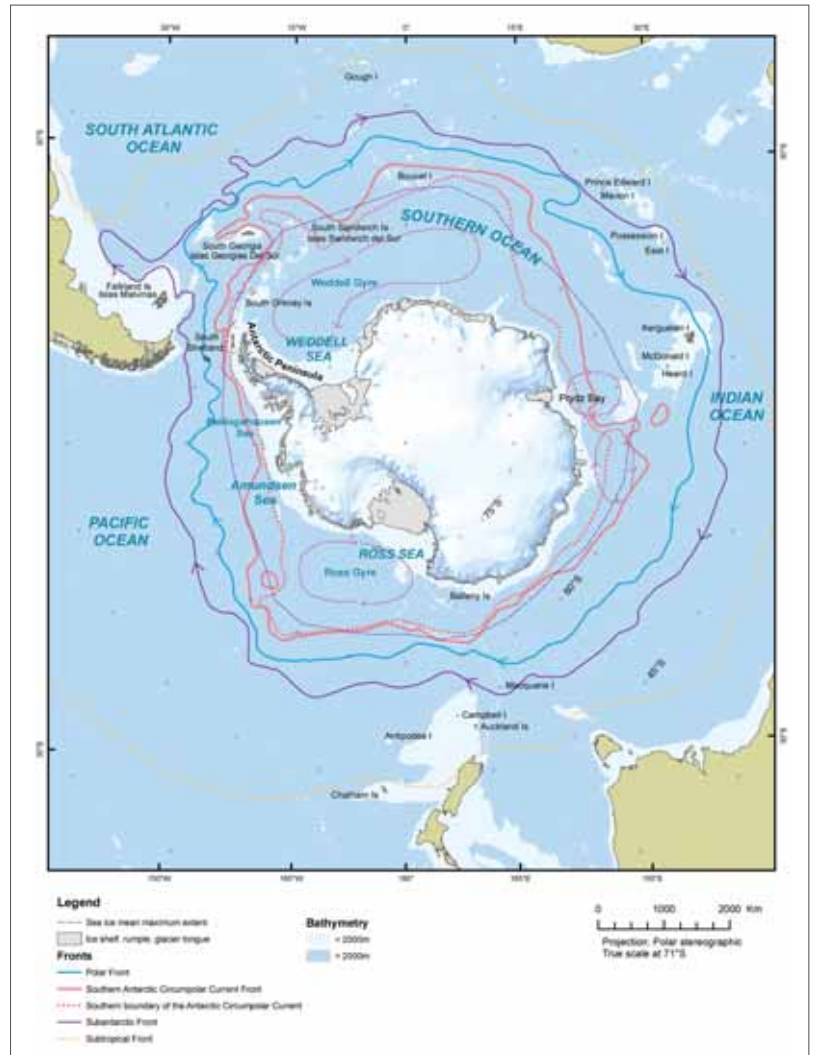

Figure 2.6. Generalised schematic of different habitats in the Southern Ocean. Vertical lines indicate the meridional division along ocean fronts. The mixed layer can fall entirely in the epipelagic during summer but can extend into the mesopelagic in winter. Red dashed arrows represent aeolian (dust) inputs to the system.

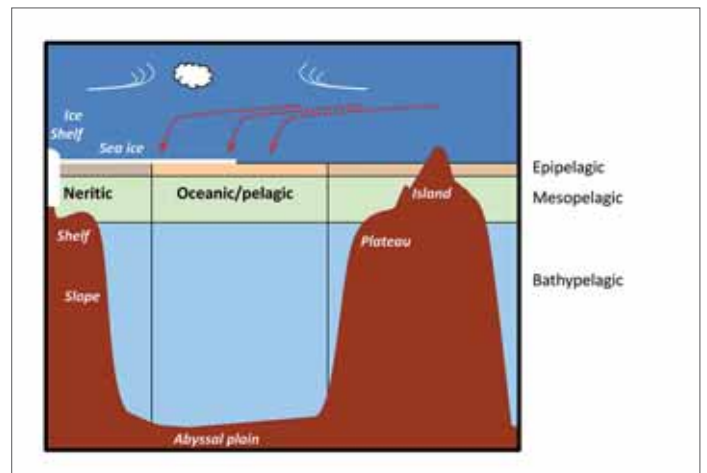
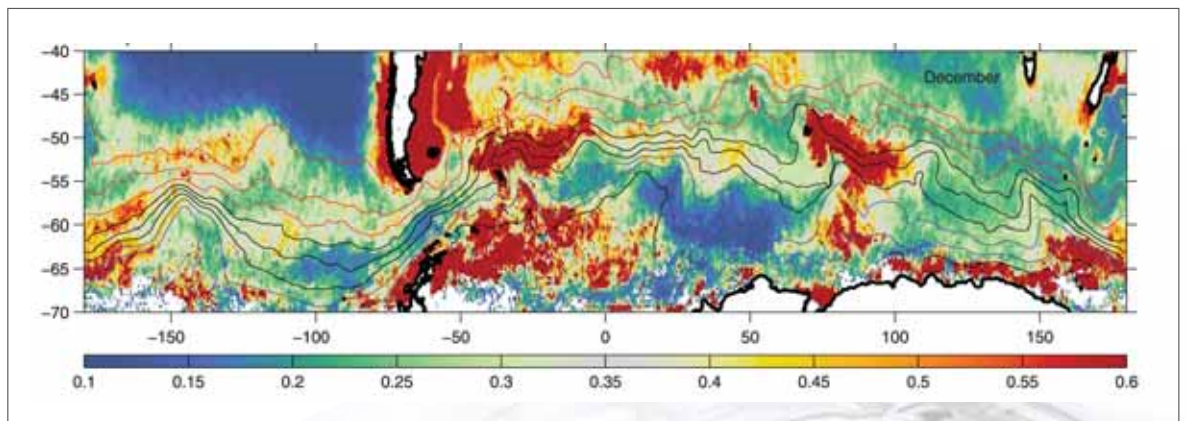

Figure 2.7. Mean distribution of Chlorophyll *a* for December averaged over the period 1997 to 2002. Ocean fronts estimated from sea surface height are shown. (Source: Sokolov and Rintoul, 2007)²⁵.



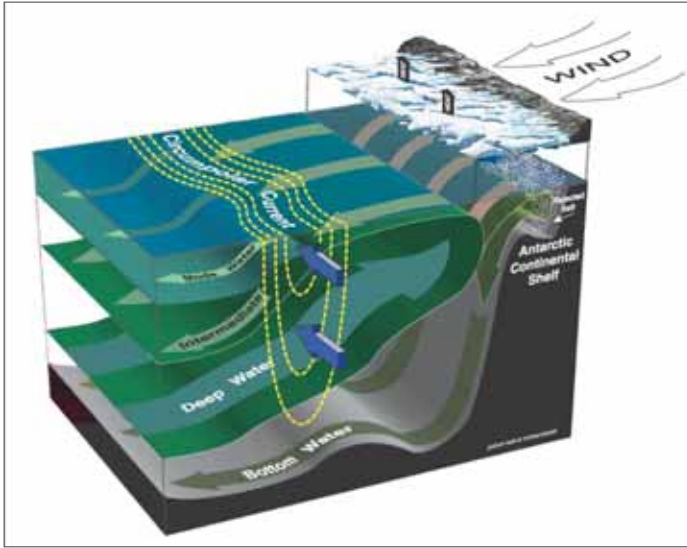

Figure 2.8. Three-dimensional structure of water masses, showing relationship between the ACC and deep water. Note subduction of the Antarctic Intermediate Water moving to the north begins at the Polar Front (Source: Rintoul, 2000)²³

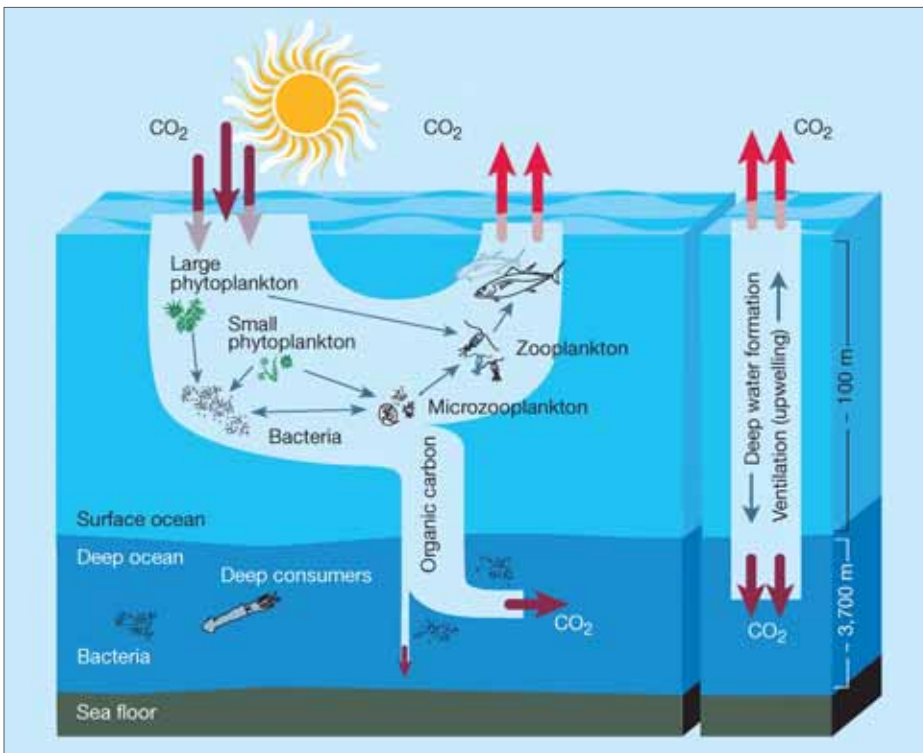

Figure 2.9. The ‘biological pump’ is a collective property of a complex phytoplankton-based food web. Together with the ‘solubility pump’ (right), which is driven by chemical and physical processes, it maintains a sharp gradient of CO_2 between the atmosphere and the deep oceans. Using sunlight for energy and dissolved inorganic nutrients, phytoplankton convert CO_2 to organic carbon, which forms the base of the marine food web. As the carbon passes through consumers in surface waters, most of it is converted back to CO_2 and released to the atmosphere. But some finds its way to the deep ocean where it is remineralized back to CO_2 by bacteria. The net result is transport of CO_2 from the atmosphere to the deep ocean, where it stays, on average, for roughly 1,000 years. The food web’s structure and the relative abundance of species influences how much CO_2 will be pumped to the deep ocean. This structure is dictated largely by the availability of inorganic nutrients such as nitrogen, phosphorus, silicon and iron. Iron is the main limiting nutrient in the Southern Ocean. (Reprinted by permission from Macmillan Publishers Ltd: Nature (Chisholm 2000), copyright 2000, <http://www.nature.com/index.html>)

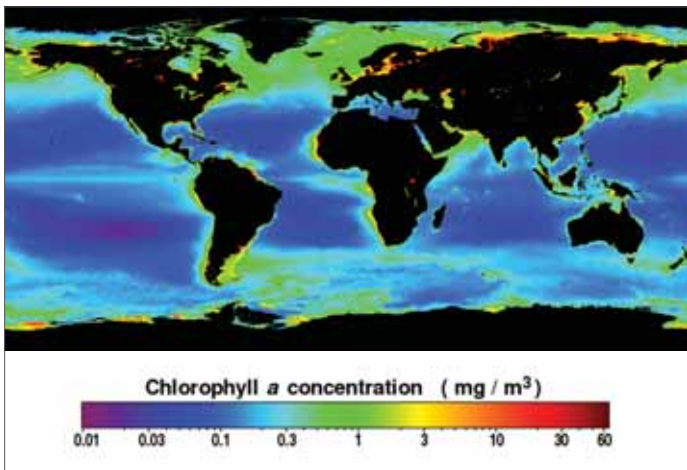

Figure 2.10. Composite SeaWiFS Chlorophyll Image 1997-2009. Source: G. Feldman, NASA-GSFC.

Figure 2.11. Maps of monthly mean Antarctic sea ice concentration and extent from a) February (minimum ice extent) and b) September (maximum extent), 2007⁶. These images were derived from US Defence Meteorological Satellite Program Special Sensor Microwave/Imager (DMSP SSM/I) brightness temperature data by applying the NASA Bootstrap algorithm⁶. Data courtesy of the NASA Earth Observing System Distributed Active Archive Center, National Snow and Ice Data Centre, University of Colorado.

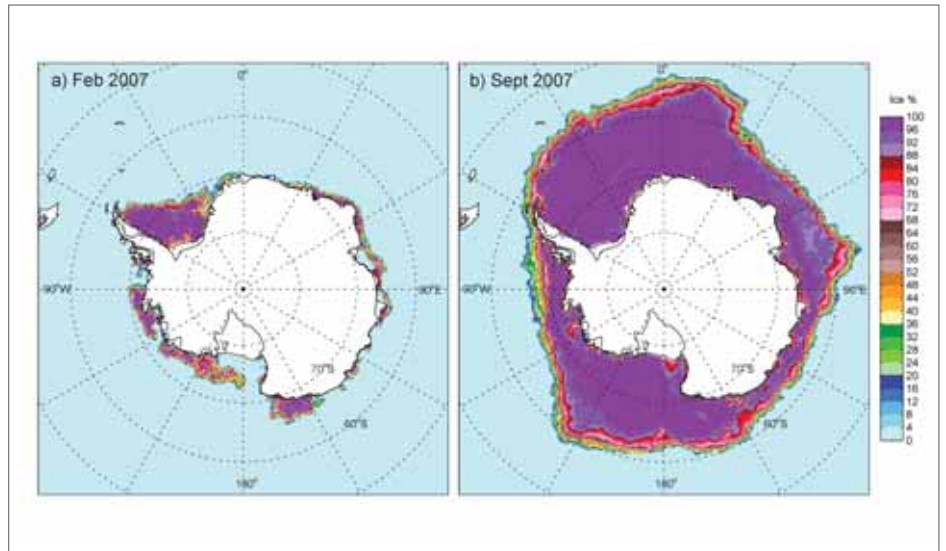

Figure 2.12. NASA Terra MODIS visible satellite image (resolution 0.25 km) showing large-scale zonation of sea ice in the region 130-160E. The inset photographs depict ice conditions in the outer pack/marginal ice zone (A), inner pack (B), in a region of annual fast ice (D) and in a polynya (E), the latter showing frazil ice streamers. MODIS image courtesy NASA.

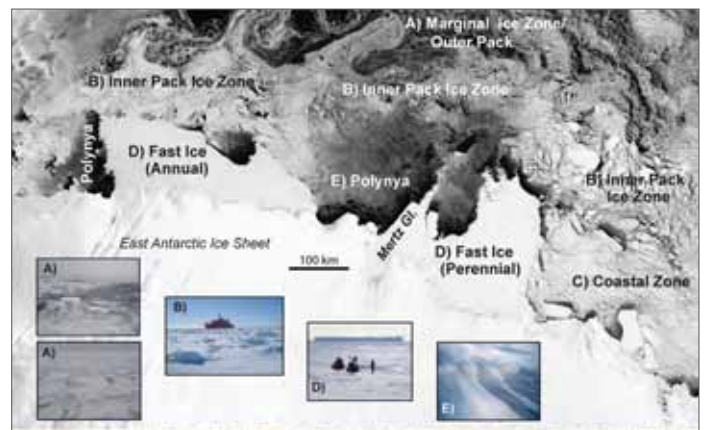

Figure 2.13. Map of climatological (mean) satellite-derived sea ice motion for 1997 (courtesy US National Snow and Ice Data Center; Fowler, 2003)⁸, with broad-scale sea ice sectors.

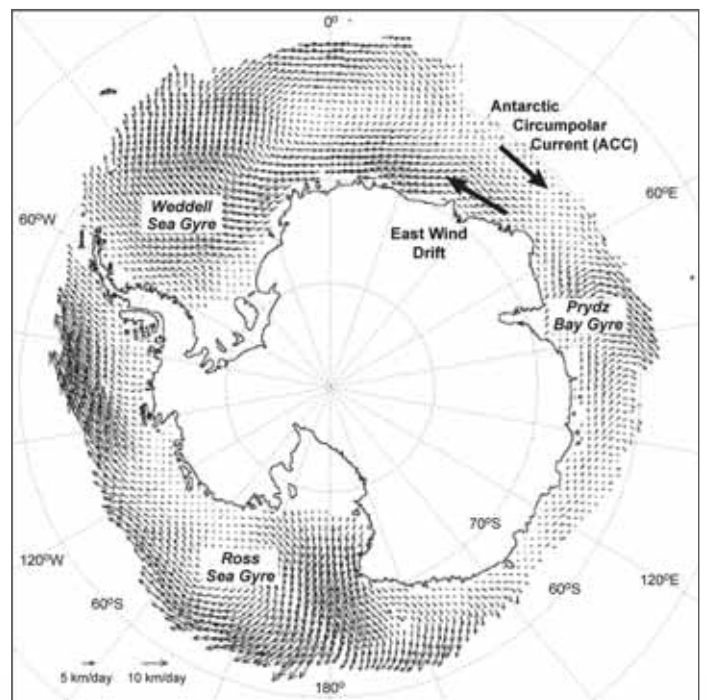



Figure 2.14. Sea-ice communities may consist not only of phytoplankton but also of a variety of biota that resemble benthic (bottom-living) fauna. They may take up residence on top of, within or on the bottom of floes. Such communities survive a wide range of salinities and temperatures below -6 degrees Celsius. Sea-ice biota may account for 20 percent of overall productivity in the Southern Ocean. (Source: Nicol and Allison, 1997)²¹

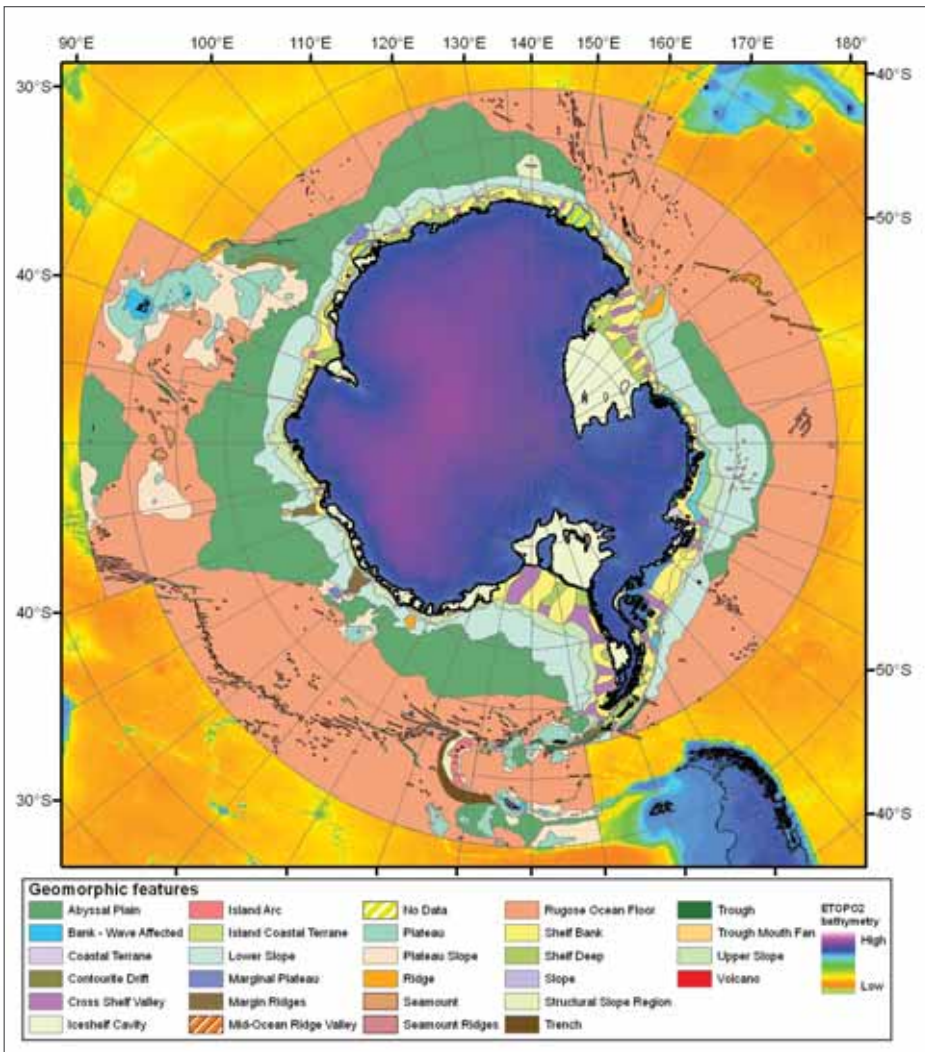

Figure 2.15. Geomorphic units of the Antarctic Margin and Southern Ocean Topography and bathymetry from ETOPO2 grid. (Source: P. O'Brien, Geoscience Australia)

Figure 2.16. Conceptual schematic diagram of the Antarctic coastal marine zone highlighting processes that may drive, or are involved in, (bio) regionalisation. Basic elements are the coastline, the continental shelf edge, and islands. Other fixed features are also labelled. Residual pack ice in this case refers to regions of perennial sea ice i.e., sea ice that persists through the summer to survive the melt season. Fast ice and polynyas etc. are more extensive in reality than depicted here. Figure developed by H. Keys (DOC, New Zealand) and R. Massom, based on other work including Beaman and Harris (2005)² and Massom *et al.* (2001)¹⁶.

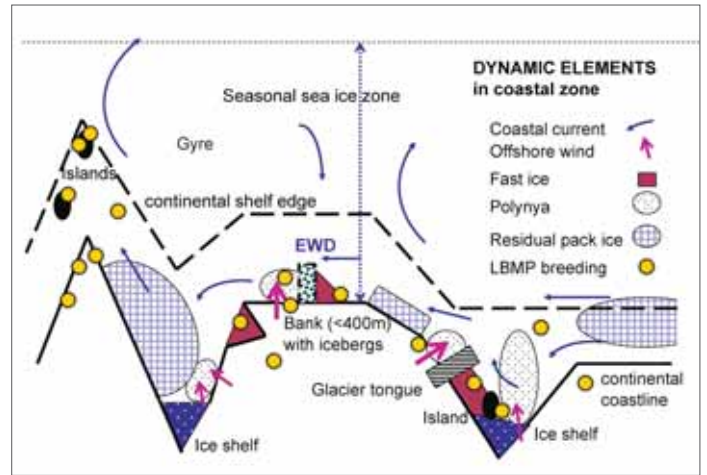
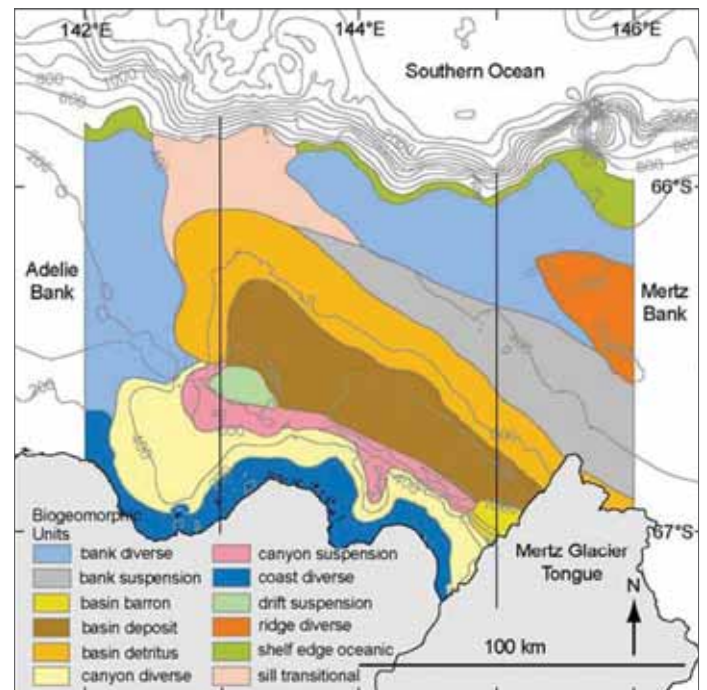

Figure 2.17. Biogeomorphic units from the George V shelf², around the Mertz Polynya, which is a location of Antarctic Bottom Water formation²⁸. (Source: Beaman and Harris, 2005).





3. Biota Of The Southern Ocean

Potential impacts of climate change on the structure and function of Southern Ocean food webs and ecosystems will be dictated, in the first instance, by the sensitivity of organisms to change in the physical environment. The overall dynamics of the system will then be determined by the influence of affected species on other species in the food web, whether that influence is as predators, prey, competitors or in some other role. Organisms benefit from adequate resources to meet their needs, mates for reproduction, and protection from predators. An organism's morphology, physiology, life history and behaviour will determine the types of habitats in which it can live, as well as how it relates to other organisms. This section introduces the different biota found in the Southern Ocean. It also outlines some of the functional attributes of organisms that will influence where species might be found now and in the future and how successful they will be in those areas. It concludes by considering the general nature of Southern Ocean food webs and the regional differences in the ecosystems.

Like organisms inhabiting the Arctic, those found in the Southern Ocean differ from the rest of the world's oceans because they are adapted to colder conditions and many have a dependency on the annual advance and retreat of the sea ice. These attributes, and the fact that Antarctic organisms have evolved over a long period of geographic and climatic isolation, make the biota of the region very sensitive to climate change impacts. It is not yet fully understood how these organisms are at future risk from climate change impacts on their physical environment nor how affected species might impact on the dynamics of other species in the same habitats or in other habitats⁴². However, there is a sound basis from which to explore plausible scenarios of direct and indirect impacts of climate change on Southern Ocean biota^{42, 55, 56}.

3.1. Southern Ocean Biota

3.1.1. Protists And Microbes

Protists and microbes include autotrophs (phytoplankton), mixotrophs and heterotrophs. They are the foundation of life in the Southern Ocean (Figure 3.1). Phytoplankton convert light, combined with carbon dioxide and nutrients, into consumable energy for other organisms (Figure 3.2). The abundant groups of phytoplankton in the Southern Ocean are the diatoms, flagellates and the prymnesiophyte, *Phaeocystis antarctica*³⁵. Other microbes that are essential in maintaining production in the surface waters are bacteria, viruses and small heterotrophs in what is known as the microbial loop³⁴. At present, microbial diversity and ecology are poorly understood in the Southern Ocean.

Antarctic krill tend to consume larger diatoms. Other zooplankters, such as salps and copepods can exploit these diatoms as well as smaller size classes. These larger diatoms are found throughout the Southern Ocean but restricted to areas where there are sufficient quantities of iron and silica (Figure 3.3), the latter of which is the foundation of their skeleton. The other main group to form blooms is *Phaeocystis*, which is found to dominate in the Ross Sea.

An important heterotrophic protist group are the Foraminifera, which have an external calcareous shell. This group is widespread throughout the ocean and, with other calcareous and siliceous organisms, are an important component of the fossil record in marine sediments providing information on regional oceanic productivity, the presence of different water masses, ocean temperature (from stable isotope ratios) and sea ice distribution over geological time³⁷.

Protists and microbes form the foundation of biogeochemical processes^{8,34}, often considered primarily in open ocean habitats. However, during winter, these assemblages may also occupy the brine channels within sea ice or the subsurface of the sea ice.

3.1.2. Zooplankton

Zooplankton is an omnibus group that needs to be subdivided into smaller functional groups³, taking account of all of the generalised attributes discussed below – size (micro-, meso- and macro-), life history, mobility, and feeding type (Figure 3.4).

Antarctic krill is the best known of this group, having attributes more similar to small fish than many zooplankton species⁴⁶. They are macrozooplankton (or micro nekton)², live for up to seven years, grow to approximately 60mm in length and take 3 years to become reproductively mature. Their life stages are separated (Figure 3.5). Adults are found more offshore and in deeper water than the juveniles^{2,46}, which tend to be found associated with sea ice habitat grazing on the algae growing under the ice⁵⁴. Adults can move quickly and, as large aggregations (swarms), can rapidly consume all smaller organisms in an area, including phytoplankton and small life stages of animals, which may be eggs, larvae, juveniles or adults. A number of other less common euphausiid species are found in the Southern Ocean with crystal krill being common in shelf areas around the Antarctic continent.

Salps (tunicates) are common omnivorous macrozooplankton, which feed by filtering sea water. They tend to be more oceanic in their location compared to krill. Salps have been observed to alternate with krill in some locations and may compete with krill for food³⁸.

An often-forgotten group of macro-zooplankton are the active carnivorous species, dominated by amphipods (*Themisto gaudichaudii*) and chaetognaths, and including siphonophores, medusae, polychaetes, and large pteropods³.

In terms of total biomass, the zooplankton in the Southern Ocean are dominated by the mesoplanktonic copepods³. Species in this group vary in size, feeding mode and life history. Copepods are at the base of an alternative energy pathway to the krill-based food web and can have a substantial influence on dynamics in local areas (see 3.4 below)⁴⁵. Hence, care is needed in correctly representing this group in food web models.

Pteropods are widespread and abundant gastropod molluscs generally considered to be macrozooplankton. They are divided into two groups - shelled and naked. The shelled pteropods have shells of aragonite and are primarily herbivores. These animals are considered vulnerable to increasing ocean acidification. Naked pteropods are carnivores. Although not much is known about this whole group, a recent review has shown that they may have an important role in the ecosystem³³.

3.1.3. Mesopelagic Species

The most important groups of mesopelagic nekton are the lantern fish (myctophids)¹⁴ and squid¹³. Sharks are mesopelagic predators but are much less important in the Southern Ocean than elsewhere in the world.

Lantern fish grow to between 50 and 150mm in length and form large aggregations, feeding on zooplankton⁵⁸. They are the most abundant mesopelagic group in the Southern Ocean^{13,22,23,66}, easily observed with acoustic technologies (Figure 3.6) because they have swim bladders. Many have a similar life history to Antarctic krill. They actively undertake daily migration over 100s of metres in only a few hours around dawn and dusk^{7,13,24,66}. Species may be segregated by depth and also by whether they rise to the surface during the day or during the night. Some are restricted to neritic zones (Figure 2.6) around the continent and islands, while most are found throughout the Southern Ocean.

A neritic schooling fish important to the food webs near to the Antarctic continent is the Antarctic silverfish, *Pleurogramma antarcticum*.

Squid are very important in the diet of toothed whales, elephant seals and some fish. They are also likely to be very important predators of fish and krill and, as juveniles, zooplankton. However, they are poorly understood because most knowledge of these species is from specimens found in the stomachs of predators. Squid are believed to be relatively short-lived and can have different life histories depending on whether they have a neritic or oceanic habit¹³.

3.1.4. Bathypelagic Species

Bottom-dwelling and deep water fish fauna of the Southern Ocean is dominated by the families Nototheniidae and Channichthyidae (icefish)³⁶. The most well known of these species are current commercial species, Patagonian and Antarctic toothfish and the mackerel icefish. Many notothenids (such as Antarctic marbled cod) and channichthid species (such as mackerel icefish), were depleted through commercial fishing conducted between the late 1960s and ending in the mid-1980s.

Icefish are cold and shallow water species found south of the Polar Front and live near to the sea floor on the shelf areas around the continent and subantarctic islands. Some species, such as mackerel icefish, will form aggregations, rising off the bottom at night to feed. Icefish tend to be short-lived (<10 years old) and their diet consists primarily of zooplankton.

Notothenids are also cold water species, although the distribution of toothfish extends to the north of the Subantarctic Front, along the eastern and western margins of South America and in some island and ridge areas in the Indian Ocean. They are found on the shelf and slope areas around the continent and subantarctic islands, with some species being recorded at depths of 2 500 metres. Notothenids are long-lived (>20 years) and eat zooplankton, small fish and scavenged material.

There are numerous deep water benthic predatory and scavenging fish species that live on the sea floor, including skates, grenadiers, liparids and zoarcids. Their biology is poorly understood in this region.

3.1.5. Benthos

Bottom-dwelling invertebrates live on the detritus raining from the productive surface waters of the ocean. They comprise suspension, filter and deposit feeders. A number of recent reviews describe the evolution and ecology of benthic fauna^{4,9,10,12,30}. Scientific understanding of the richness of the benthic fauna in the Southern Ocean is improving dramatically through recent programs¹⁰, such as the Census of Antarctic Marine Life (CAML). However, their distribution and abundance are only poorly understood, except for some intensive studies that have related benthic habitat types to geomorphological features on a small scale⁵. Habitat-forming taxa provide structure on which other organisms depend either above the surface as three-dimensional structures, such as sponge beds or hydrocoral reefs,

or within the substratum, such as burrows. Recently, extensive hydrocoral reefs were discovered on the continental slope of Antarctica (Figure 3.7). Hydrocorals have a limestone skeleton, which may be at risk with higher acidity of sea water. Benthic habitats are becoming increasingly recognised as being important in the nutrient cycling and dynamics of marine ecosystems.

3.1.6. Marine Mammals and Birds

Populations of marine mammals and birds display an obvious visible signal of the long-term dynamics of marine ecosystems. Increasing populations would intuitively suggest increasing system productivity while declining populations indicate declining system productivity. All of them will be impacted by the influence that climate change has on the lower levels of the food web^{60, 62}. However, the relationship is clearly not always straight forward because other factors, including interactions amongst predator species as well as the influence of environmental conditions, might interfere with the ability for these predators to find food and/or to successfully reproduce⁶⁰. Some of these animals are dependent on physical conditions that are directly impacted by climate change, such as how emperor penguins depend on fast ice for breeding. There is also the potential for climate change to disrupt the link between the timing of breeding phenology and peak prey availability²⁷.

Marine mammals and birds typically mature late, live longer than 15 years and have only one or two offspring each year once mature. Some species do not reproduce every year and individuals will not reproduce if their body condition is poor. For some species only breeders or those seeking to breed will arrive in the colonies, while for others there can at times during the breeding season be many non-breeding individuals present at the colony.

Although most marine mammals and birds have the capacity to forage widely in the Southern Ocean (Figure 3.8)⁶, particularly during the winter months, there is increasing evidence that adult animals will tend to forage in the same general locations, returning to the same land-based colonies or breeding grounds to reproduce. During breeding in spring and summer, species tied to land-based colonies will restrict their foraging range in order to avoid starving their young or their partners. Typical land-based breeders include fur and elephant seals, penguins and flying birds. Pack-ice seals tend not to be restricted in their

range for very long while breeding, although they do maintain a close proximity to the sea ice.

There is a height of predator activity occurring in the Southern Ocean during spring and summer which coincides with the breeding season for many species^{19, 60}. This is the time when all the consumers return to the region to feed (Figure 3.9). Much of this activity is concentrated within the foraging ranges of the breeding colonies. During this period, the sea ice is retreating or absent. Some penguins and seals remain associated with the sea ice zone all year but these are only a few compared to the number that engage in the land-based summer activity. For those species that feed primarily on krill when it is abundant, which is most marine mammals and birds, access to food can be restricted by heavier sea ice in any given year, thereby impacting breeding success²⁵. Some baleen whales concentrate their foraging activities at the sea ice edge as it melts⁴⁹.

Not all predators eat krill. For example, elephant seals, small toothed whales and sperm whales predominantly eat fish and squid. Those species that are highly dependent on krill can also have a varied diet including fish and squid. The highest order predators in the Southern Ocean are the orca and the leopard seal²⁶.

Diving and foraging strategies vary amongst the marine mammals and birds. Most flying birds tend to feed in the top tens of metres of the ocean while Adelie penguins typically forage to 100 metres and Emperor penguins often forage between 50-400 metres^{63, 64}. Most seals forage within 200m of the surface, making regular trips to the desired depth. In contrast, elephant seals and whales can dive to many hundreds of metres and stay for long periods at depth. Recent studies using time-depth-position recorders are showing how particular predators have consistent foraging patterns and, in so doing, may partition the marine environment (Figure 3.10)¹⁸.



3.2. Life In The Ocean

The scales at which different species function, i.e. their size, generation time and the distances over which they obtain food, are important for understanding how changes in the physical environment may change the dynamics in the food web and, in some cases, vice versa⁴³(Figure 3.11). Thus, food web dynamics are not simply based on big eats small, fast eats slow, movers eat non-movers. The overall ‘environment’ of organisms needs to include the potential climate change impacts on different linkages; can these environments be generalised in order to create plausible ecosystem models without having to represent all the ecological detail of every species?

As described in Section 2 (Figure 2.6), the general habitats of species are defined by light, depth, water temperature and chemistry, relationship with the sea floor and location relative to shelf areas and sea ice. For many species, their life stages will progress from one habitat type to another. Changes in the attributes of these habitats will potentially give rise to change in the types of species found there. For example, species that require a specific temperature range may change their location in response to a shift in temperature conditions. However, a species may not be able to do this if other essential conditions for the species are not available elsewhere.

A conceptual approach for mapping how various changes to the physical or biological environment might impact on a species was developed by Andrewartha & Birch¹. Their envirograms relate an organism to its environment by examining the factors that influence reproduction (life histories), mortality (predators and other causes, which they call malentities) and resources (nutrients, prey, food, shelter and the like)(Figure 3.12). Importantly, rather than just considering the connections amongst and between species and the physical environment as is often reflected in a food web, they concentrate on the functional connections between the components in their envirograms (i.e. how does one component affect another?) In so doing, a component may appear at many different locations in an envirogram of a species. The impact of a change in an environmental component on a subject species could be unpredictable when a component has a net positive influence on the subject in one part of the envirogram but a net negative influence in another. This is considered further in qualitative assessments in Section 5²⁰.

The approach of Andrewartha & Birch focuses on the primary attributes that determine where organisms can live and how they relate to other organisms. These attributes will also determine how well organisms will respond to environmental change, including climate change. They did not include consideration of adaptation but, clearly, evolution of species with short generation times relative to climate change impacts may also be possible.

The attributes of species that give rise to how species respond to their environments include morphology, physiology, life history, mobility, and feeding mode. These are considered in detail here to provide a foundation for considering how impacts on a species could then contribute to impacts on the dynamics of food webs.

3.2.1. Morphology and Physiology

Apart from marine mammals and birds, which are endotherms (warm blooded), all species in the Southern Ocean are ectotherms (cold blooded). Thus, their metabolism is governed by the surrounding water temperature, with warmer water meaning faster metabolism. As a general rule, vertebrates are less susceptible to changes in water chemistry than invertebrates, which, in turn, are less susceptible than unicellular (single-celled) organisms.

The size and shape of marine organisms can be a significant factor in living in a fluid environment, affecting how easily bodies move through water and how water might be moved through a body for respiration and feeding. The viscosity of seawater is such that smaller particles can be entrained in the water. Spines and other protuberances can increase the resistance to movement through water, an important factor for some phytoplankton to reduce the rate of sinking from the photic zone.

An important difference amongst similar types of biota is whether they have a skeleton. Even some phytoplankton can have a skeleton, of sorts. For example, diatoms have siliceous frustules and coccolithophores (a group of small flagellated phytoplankters) have a calcite exoskeleton. A skeleton can provide important structure as well as defence against some predators. Skeletons are mostly based on silicon, calcium carbonate (aragonite or calcite) or chitin (a polysaccharide). Many invertebrates, such as in crustaceans, have an exoskeleton. Some invertebrates, like echinoderms, have endoskeletons, which are like exoskeletons but covered by skin. Spines and other protuberances can assist in defence as well as the capture of food. Vertebrates have an internal skeleton but, as in fish, external scales and spines can help regulate



physiology in a saline environment, assist in capturing prey and provide defence.

3.2.2. Life History

The life history of an organism is its life cycle and how acquired (consumed) resources are used through its life and the priority given to different functions – maintenance (metabolism, repair, food acquisition), body growth and reproduction. Some organisms have a fixed life cycle. Other organisms can be quite ‘plastic’ as to when they grow or reproduce or the time spent in each life stage. For some, the life stages are separated and found in different habitats (e.g. Antarctic krill and many bottom-dwelling fish). Others give attention (parental care and investment) to rearing their young into the population (e.g. land-based breeders or invertebrate brooders).

Life-time reproductive output is a measure of success of the individual. For many small organisms, including single-celled organisms and zooplankton, a short life with opportunistic reproduction when conditions are optimum would be a successful life history ‘strategy’. In terms of response to a changing environment, the flexibility of an organism to survive during periods of poor conditions rather than reproducing is an important part of its strategy. As for many Southern Ocean



© Sylvia Ruji / WWF-Canon

birds and all its marine mammals, investing more in one or a few offspring in the ‘good’ years and none in the ‘bad’ helps avoid putting themselves at risk in years when offspring are unlikely to survive.

Single-celled organisms have simple life cycles that are highly responsive to changing nutrient and light conditions. Individuals reproduce by dividing their cell. Hence, populations can grow rapidly if there are enough resources to sustain the population.

By comparison, many vertebrates can take longer than 10 years to sufficiently mature to reproduce. During this time they are growing to a size that gives a hedge against starvation and preparation for large investment in a small number of young. Even then, marine mammals will gestate their young, some for more than a year. Hence, there can be quite some time lag between the period when resources were good enough to reproduce to when the young are ready to reproduce for themselves. In addition, slower growth rates mean that offspring do not place pressure on resources until some time after birth. These lags make it difficult to relate changes in a predator population with changes in its prey, particularly if other factors are also influencing the dynamics of those populations.

3.2.3. Mobility

The mobility of an organism will determine its capacity to find nutrients or prey if they are not being naturally replenished or, for pelagic species, to stay in locations where resources are plentiful. Relative mobilities of predators and prey will also determine the outcomes of feeding encounters. Dispersal of organisms to new habitable areas is an important part of maintaining populations. Dispersal can be through eggs and larvae moving in currents or with sea ice or by active migration of juveniles or adults.

Typically, there are three main divisions between biota with respect to mobility – nekton (highly mobile), plankton (poor horizontal mobility, passive drifters) and benthos (restricted to the sea floor). Many plankton have the capacity to move vertically in the water column, often in a daily cycle. Benthos can be further divided into mobile, sedentary and sessile (attached). Many benthos also use meroplanktonic larvae for dispersal.

3.2.4. Feeding Mode

Biota can generally be divided between autotrophs (gaining energy from nutrients plus either photosynthesis or chemosynthesis), mixotrophs (capable of photosynthesis and ingestion of food) and heterotrophs (gaining energy/nutrition from living or dead organic matter). Heterotrophs can be divided into seven broad categories – suspension feeders (e.g. jelly fish, sponges), filter feeders (salps, benthic tunicates), grazers (herbivores), predators (carnivores), parasites and commensals, detritivores (e.g. some polychaete worms), and benthic scavengers. Apart from the latter, examples of each category can be found in both the pelagic and benthic habitats.

The type of feeding mode combined with the relative distributions, mobilities and morphologies of the consumer and the potentially consumed will determine how much of one species is available to be eaten by another species, which is an important determinant in food web structure and function.



3.3. Food Webs

Southern Ocean food webs are more complex than the oft-cited simple phytoplankton-krill-whales food chain, with many more species involved at higher trophic levels (Figure 3.13). Food webs are often considered in terms of the productivity of the whole system, starting with primary production, or in terms of the dynamics of consumers, often beginning with top predators.

Productivity (bottom up) models are lower trophic level representations of biogeochemical processes. These show the energy and nutrient pathways between functional units, as nutrient-phytoplankton-zooplankton-detritus (NPZD) models (Figure 3.14)⁵¹. The higher trophic levels of the food web are represented by a mortality rate of zooplankton. These models are focussed on understanding the factors that drive the productivity of the ocean and the carbon cycle.

Consumer (top down) food web models relate to higher trophic levels and tend to represent species on their own or, perhaps, in closely related groups. Phytoplankton and zooplankton, if they are represented at all, are

provided as ‘forcing functions’ to give rise to natural variability in the available production that is considered important for driving the higher food web.

The absence of biological and functional detail at the lower trophic levels is often representative of our poor knowledge of the ecology of these micro-organisms. Similarly, the great taxonomic detail in higher trophic models is also a function of greater visibility of those species coupled with both a greater knowledge on species-specific processes and a general desire to represent the dynamics of individual species of higher-order predators. Recent workshops on modelling Southern Ocean ecosystems^{41, 55, 56} have considered the need to correctly represent processes at the lower trophic levels as these may give rise to a number of alternative energy pathways from lower to higher trophic levels not yet considered (Figure 3.15)⁴⁴. A further consideration in understanding food web dynamics is whether different life stages of a species need to be identified separately in the food web. For example, krill eggs and larvae may be eaten by other zooplankton, including

by krill adults, whereas adult krill are eaten by fish, squid, marine mammals and birds.

An important part of representing food web dynamics is to identify the relative overlap in space and time of the different players in the food web. While there is geographic separation of many species connected only by dispersal in the ocean currents, there is also separation by depth. Marine mammals and birds only feed on species that are within their diving range. Production from the surface waters is moved to deeper waters by detrital rain as well as through a chain of predator-prey relationships coupled with diurnal migration. Small species move to the productive surface layer, consume phytoplankton and retreat to depth. Those species are eaten by larger ones at depth, which in turn get eaten by deeper species again.



3.4. Ecosystems

Ecosystems are defined by their combined physical and biological processes. The Southern Ocean has, for many years, been thought to have ecological zones that comprised concentric rings around Antarctica, with changing ecosystem structure as one moves further south^{17, 39}; the most commonly cited zones, based on productivity and sea ice, are the Permanently Open Ocean Zone, the Seasonal Ice Zone, the Coastal and Continental Shelf Zone and the Permanent Ice Zone⁶¹. This division is consistently observed amongst zooplankton assemblages³². Nevertheless, a recent pelagic bioregionalisation of the Southern Ocean²⁹ shows considerable physical and ecological heterogeneity in the Southern Ocean (Figure 3.16)²⁹.

Different locations in the Southern Ocean are dominated by different suites of physical processes and have different food webs³⁵. For example, the Ross Sea is different from the Weddell Sea and the Kerguelen Plateau is different from the Scotia Sea (comprising the region from the South Shetland Islands, through South Orkney, South Georgia and South Sandwich Islands [Isla Georgia del Sur y las Islas Sandwich del Sur])⁵⁰. This differentiation is important to recognise.

Six meridional sections of the Southern Ocean can be identified based on bottom topography, currents, sea ice, and nutrients. Three of these have the highest productivity in the Southern Ocean:

- (i) southwest Atlantic, including the Scotia Sea and the western and northern margins of the Weddell Sea,
- (ii) southern Indian, including Prydz Bay and the Kerguelen Plateau, and
- (iii) southwest Pacific, including the Ross Sea, Balleny Islands and Macquarie Ridge.

The importance of Antarctic krill varies throughout the Southern Ocean (Figure 3.17)^{17, 47}. Antarctic krill dominate in the southwest Atlantic around the Antarctic Peninsula, Scotia Arc and Weddell Sea (i.e. the western margin of the Weddell gyre)⁴⁴. In this area, other invertebrates and mesopelagic fish are only important as prey in years when krill recruitment has been poor⁵⁸; the reproductive performance of krill predators is generally down in those years also (Figure 3.18)⁴⁴. In the Ross Sea, particularly along the western margins, crystal krill and the Antarctic silverfish are also important prey species over the shelf area (Figure 3.19)^{53, 59}. Antarctic krill

is important in the north west of this area near to the Balleny Islands. In the area around Prydz Bay and the Kerguelen Plateau, Antarctic krill is important south of the Southern Boundary of the Antarctic Circumpolar Current⁴⁸ but myctophid fish dominate to the north of that on the Kerguelen Plateau²³. In Prydz Bay, the third largest embayment in Antarctica, crystal krill are important along with Antarctic silverfish^{31, 65}. Notably, this area has a mix of the shelf, Antarctic krill and myctophid fish foodwebs.

In the other areas, there is a clear zonal demarcation of the region near to the continental shelf of Antarctica from the subantarctic areas, with the most notable area of productivity being in the Bellingshausen Sea and western Antarctic Peninsula²¹.

3.5. Figures & Tables

Figure 3.1. Scanning electron micrographs of protists showing different body forms. Row 1 : heliozoan (*Acanthocystis perpusilla*) (Photographer: John van den Hoff); choanoflagellate (*Kakoecca antarctica*) (photographer: Fiona Scott); diatom (*Chaetoceros bulbosus*) (Photographer: Fiona Scott)

Row 2: dinoflagellate (photographer: Miguel de Salas); dinoflagellate (photographer: Miguel de Salas); flagellate (*Pyramimonas gelidicola*) (photographer: Sandy Melloy)

Row 3: ciliate (*Myrionecta* sp.) (photographer: Fiona Scott); diatom (*Corethron* sp.) (photographer: Fiona Scott); diatom (photographer: Cathryn Wynne-Edwards)

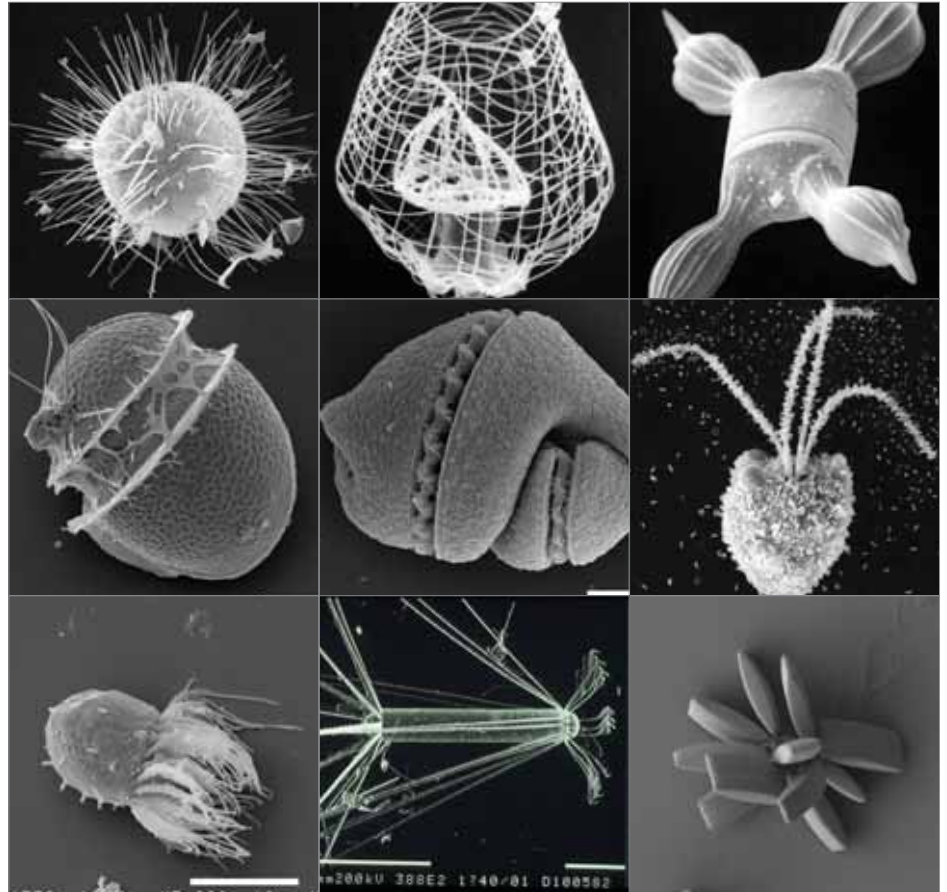
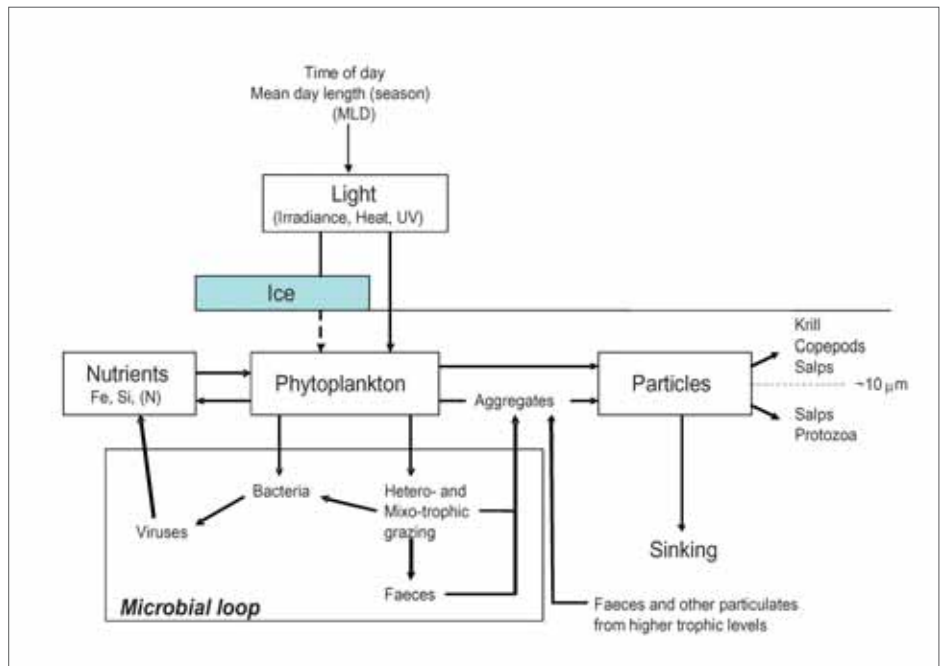

Figure 3.2. Conceptual model of the important linkages influencing production of particulates used as food by zooplankton. MLD = mixed layer depth. Note that Dissolved Organic Matter is a waste product from all organisms and DOM and Particulate Organic Matter is an important source of carbon in winter. (Source: Andrew Davidson, Simon Wright, Harvey Marchant & Graham Hosie, Australian Antarctic Division)¹⁶



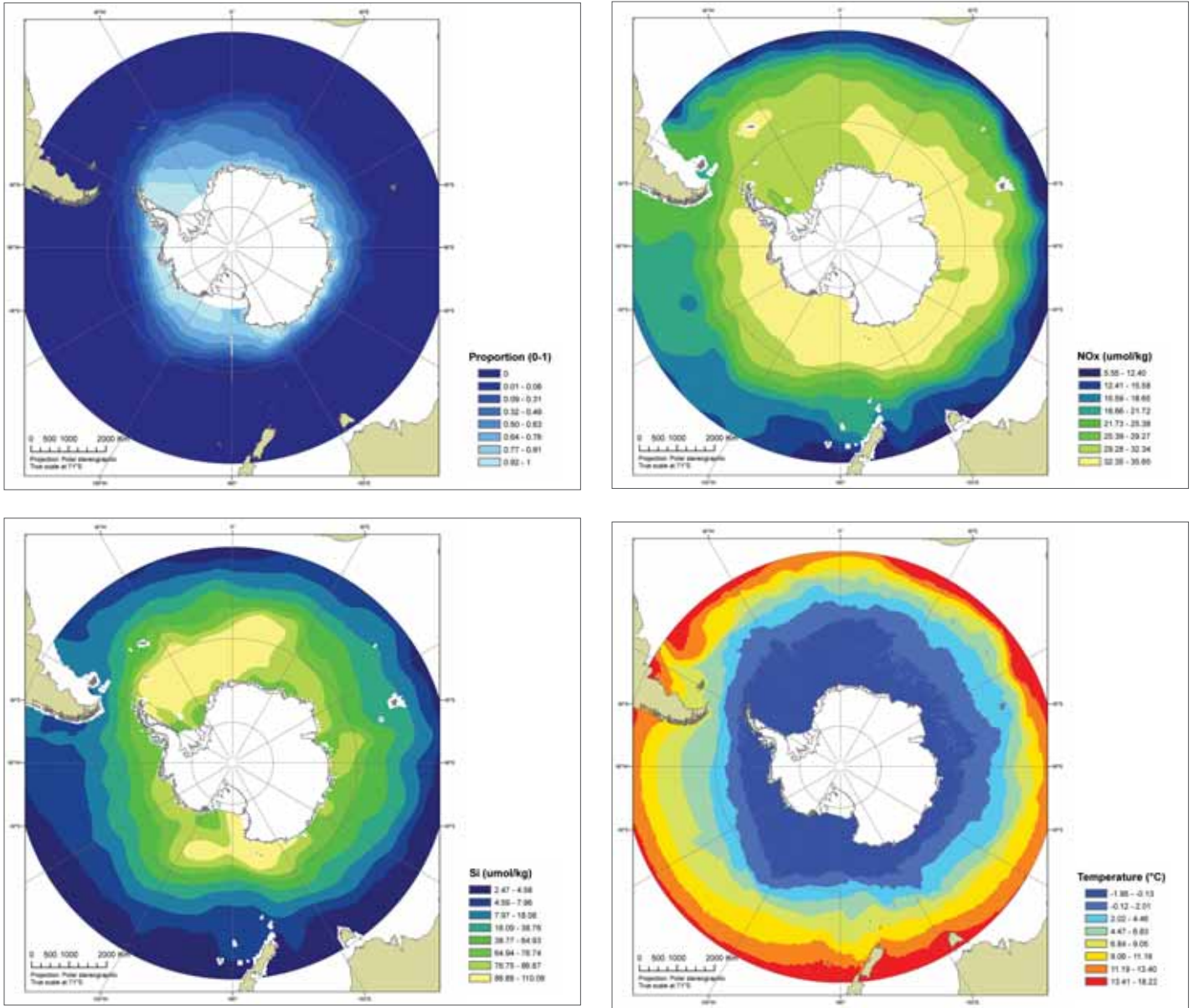
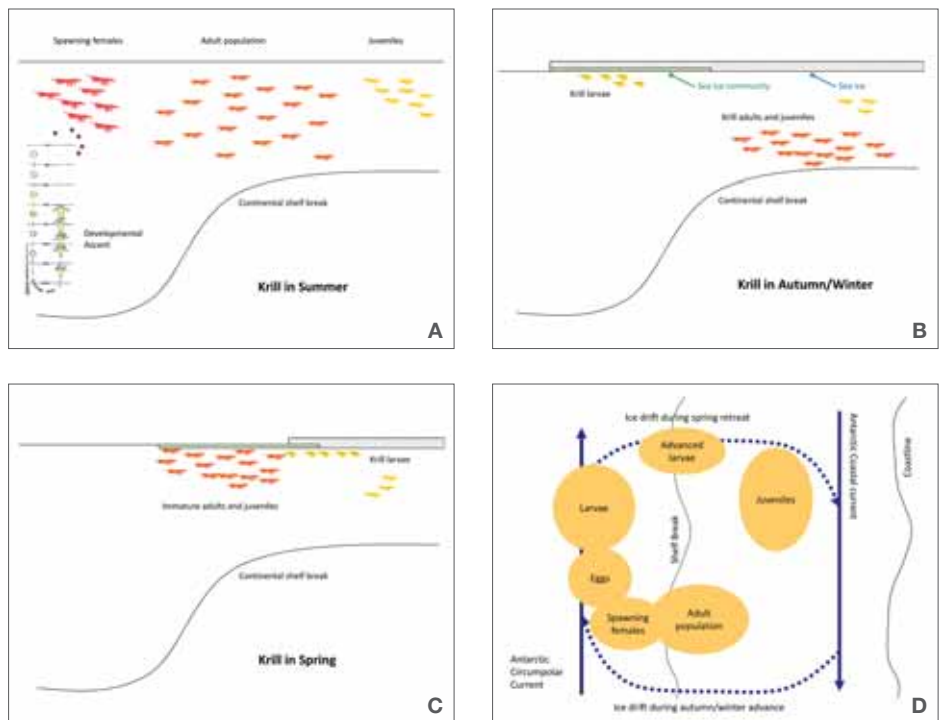

Figure 3.3. Attributes of the ocean influencing phytoplankton productivity (Source: Grant *et al.* 2006)²⁹. (a) Mean annual sea surface temperature (SST). Monthly values from NOAA Pathfinder satellite annual climatology, averaged over the period 1985-1997¹¹. (b) Proportion 0-1) of the year for which the ocean is covered by at least 15% sea ice. Calculated from satellite-derived estimates of sea ice concentration spanning 1979-2003¹⁵. (c) Nitrate concentration (at 200m depth). Climatology from the WOCE global hydrographic climatology²⁸. (d) Silicate concentration (at 200m depth). Climatology from the WOCE global hydrographic climatology²⁸

Figure 3.4. Zooplankton from the Southern Ocean. Antarctic krill, *Euphausia superba*, etc. (Photographs: Russ Hopcroft, University of Alaska Fairbanks, Census of Marine Life, 2009)



Figure 3.5. Simplified seasonal representation of the vertical and horizontal distribution of krill from offshore (left) to onshore (right): (a) summer, (b) autumn-winter, and (c) spring. (d) Seasonal ontogenetic migration pattern of Antarctic krill, showing how the krill utilize the gyral circulation patterns that link the offshore and coastal current systems (Source: Nicol 2006)⁴⁶



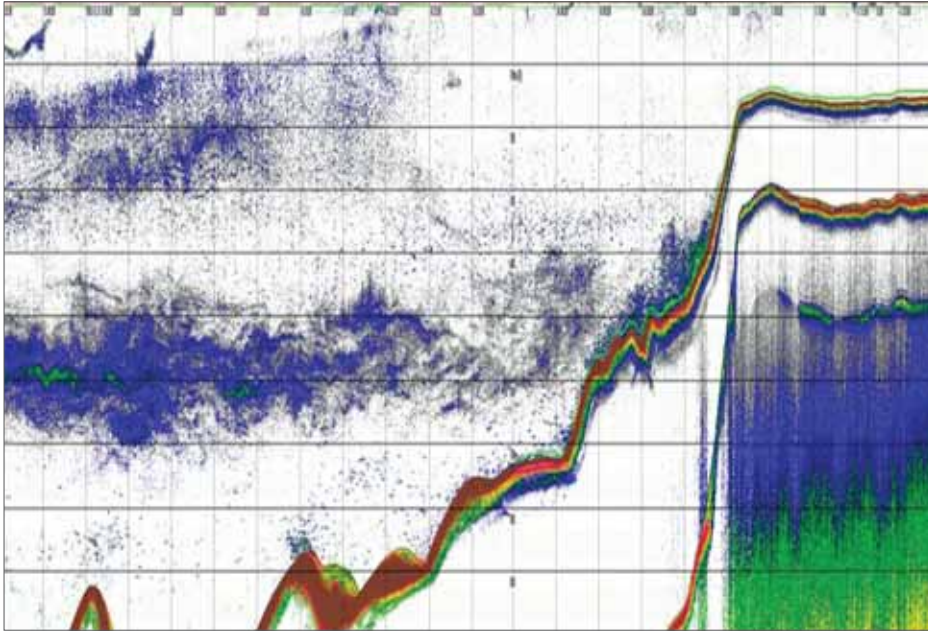

Figure 3.6. Typical echogram of acoustic marks showing myctophid fish layers in the ocean off the shelf break near to Heard Island in the southern Indian Ocean (Australian Antarctic Division, 2004). Orange-red line is the sea floor. Fish are myctophid fish usually found in these layers. (Photo: A. Constable, AAD & ACE CRC)



Figure 3.7. Benthos in the vicinity of the Mertz polynya on the Antarctic continental slope taken during the CEAMARC voyage as part of the Census of Antarctic Marine Life, 2008 (Australian Antarctic Division) (Photos: Australian Antarctic Division)

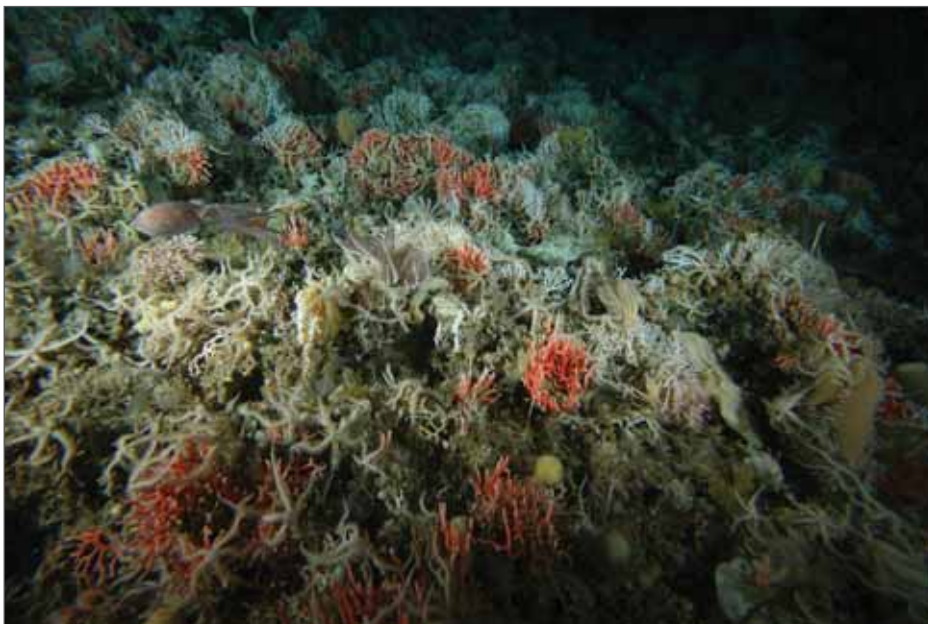
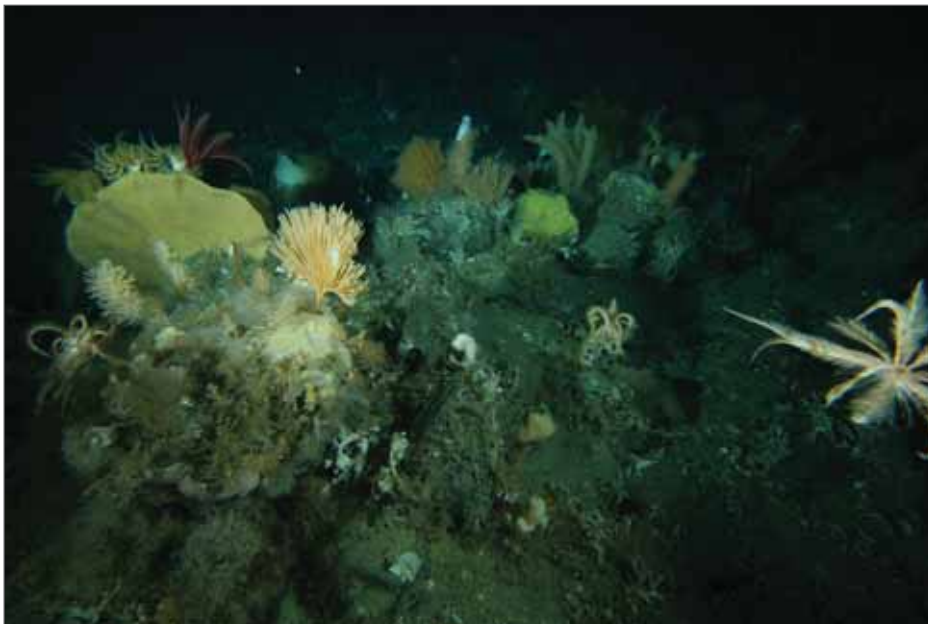

Figure 3.8. Elephant seal tracks from combined database. The circumpolar movements of 85 southern elephant seals between January 2004 and April 2006. Colony locations are at South Georgia, Kerguelen, Macquarie, and the South Shetlands Islands. Seals in the Atlantic sector show a preference for ACC waters compared with the rapid southerly migrations by most Kerguelen and Macquarie seals across ACC waters toward the continental margin of East Antarctica or into the Ross Sea. The longest track was 326 days. (Source: Biuw *et al.* 2007)⁶

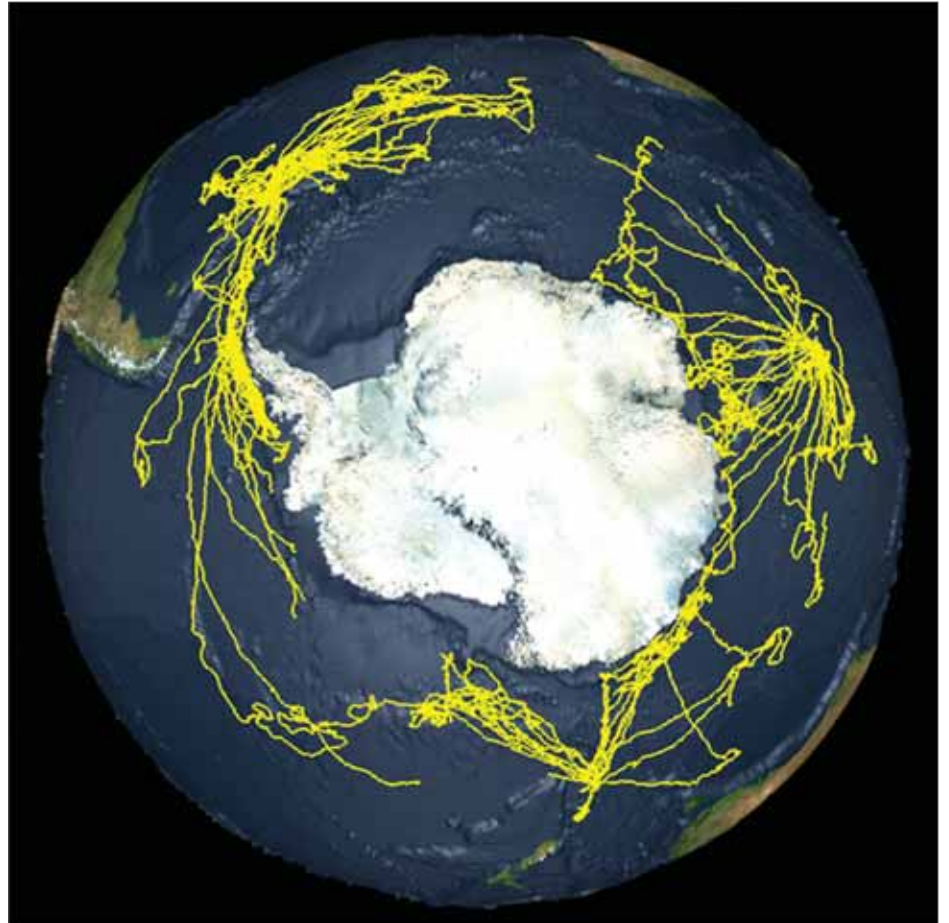
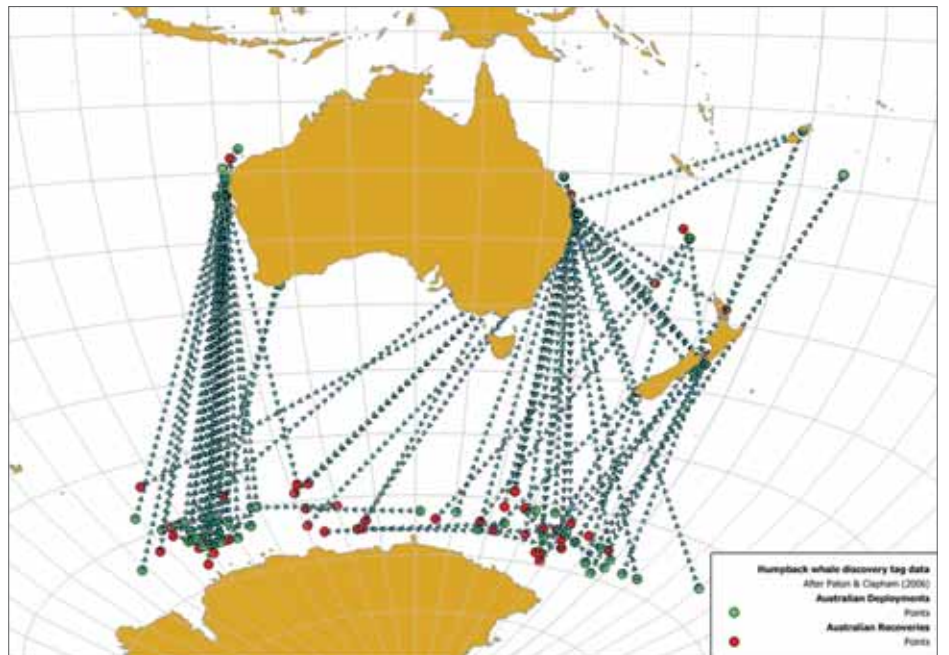

Figure 3.9. Mark and recapture points of humpback whales from the Discovery tag series, showing the movement of humpback whales from the tropics to the main feeding grounds for these populations to the east of Prydz Bay (left) and the west of the Ross Sea (right). (Source: Paton & Clapham, 2006)⁵²



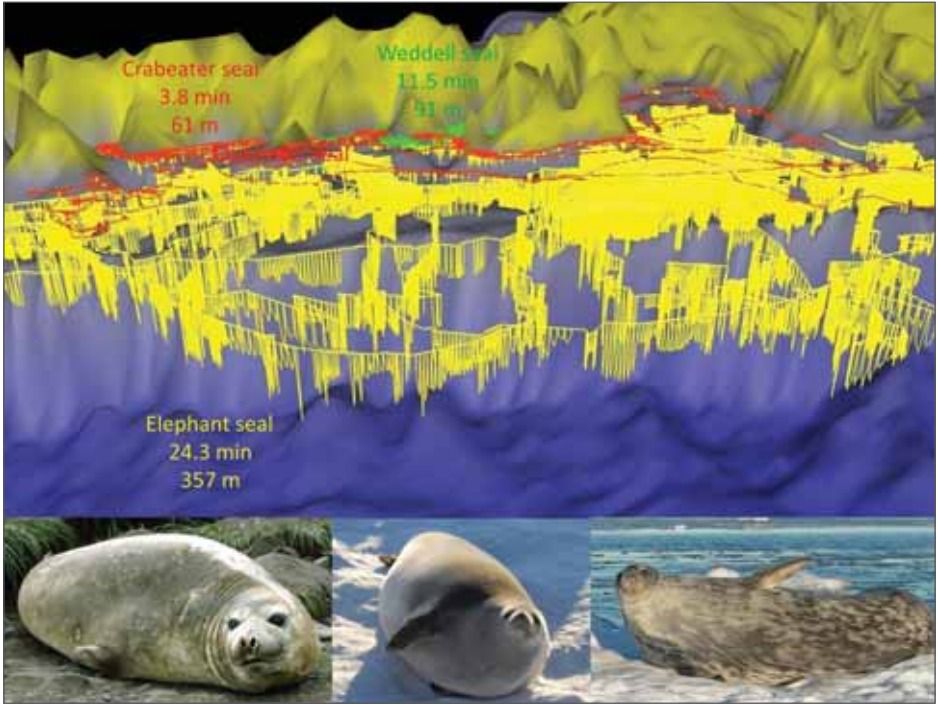

Figure 3.10. Tracks of three species tagged during 2007 in the Western Antarctic Peninsula using a SRDL tag produced by SMRU. The various colors represent the surface track of the animal, where Green = Weddell seals, Yellow = southern elephant seals, red = crabeater seals, the yellow vertical lines are the actual dives of the animals. (Source: Unpublished data from Costa, Goebel and Crocker, University of California Santa Cruz & NOAA) Seal photos: left - elephant, centre = crabeater, right = Weddell. (Photos - D. Costa, UCSC)

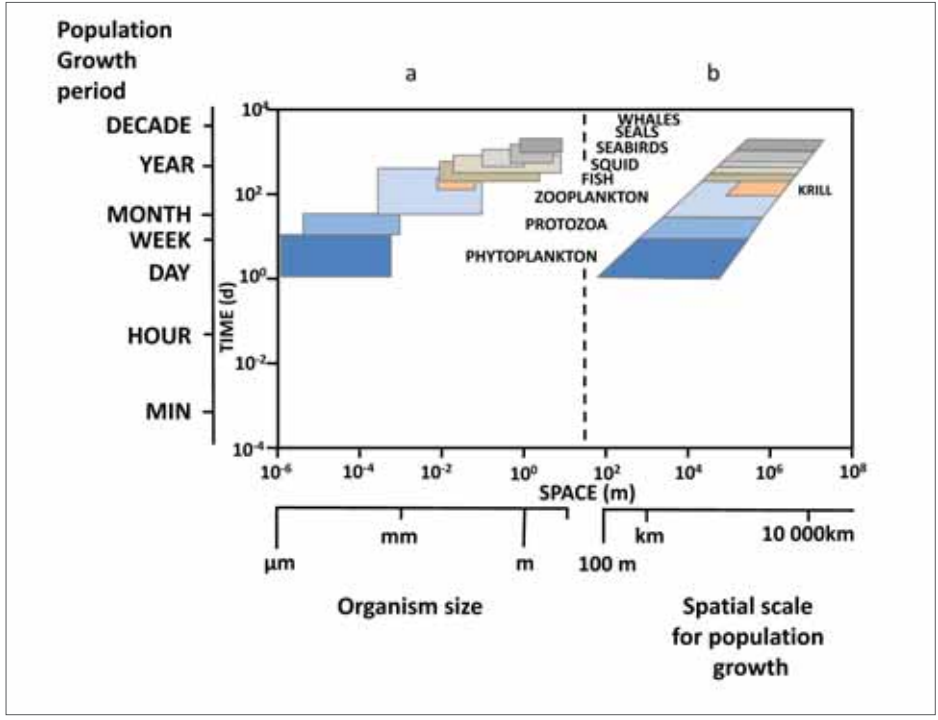

Figure 3.11. Relationship of the population growth period to (a) an organism's size, and (b) the spatial scale for population growth in the Southern Ocean (after Murphy *et al.* 1988)⁴³

Figure 3.12. A simplified example of an Andrewartha & Birch envirogram for krill, showing the roles of different components in the environment of krill. Arrows indicate the direction of impact. (+) shows a positive correlation of the response of a component to the magnitude of the impact. (-) means a negative correlation. (+/-) means a non-linear response. The multiple functions of sea ice and temperature in the environment of krill could lead to complex dynamics, particularly in cases where non-linear relationships arise.

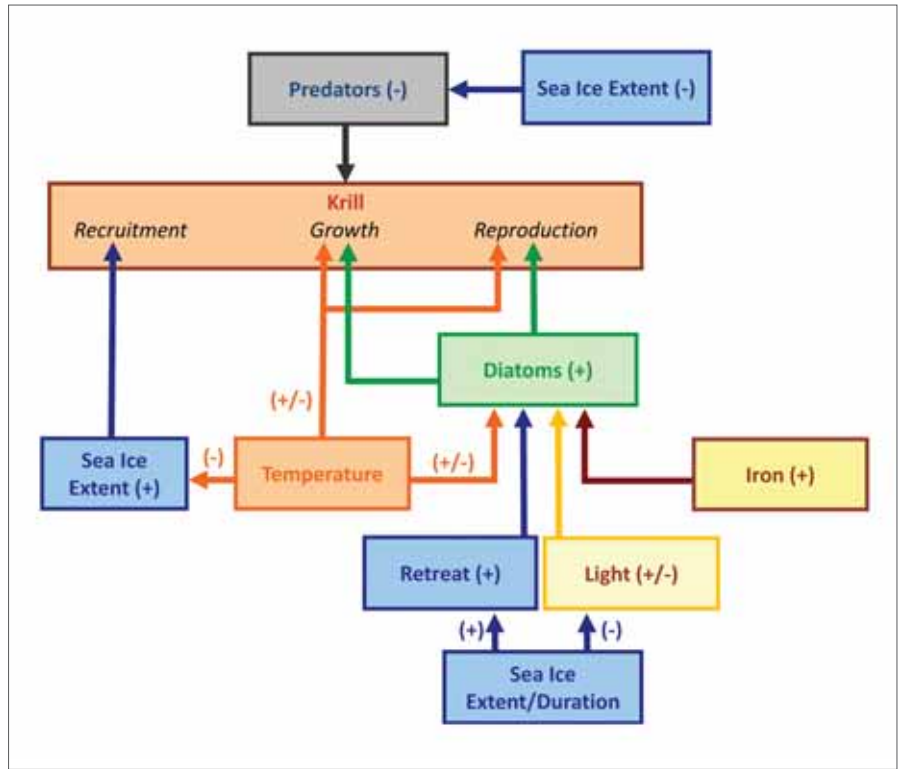
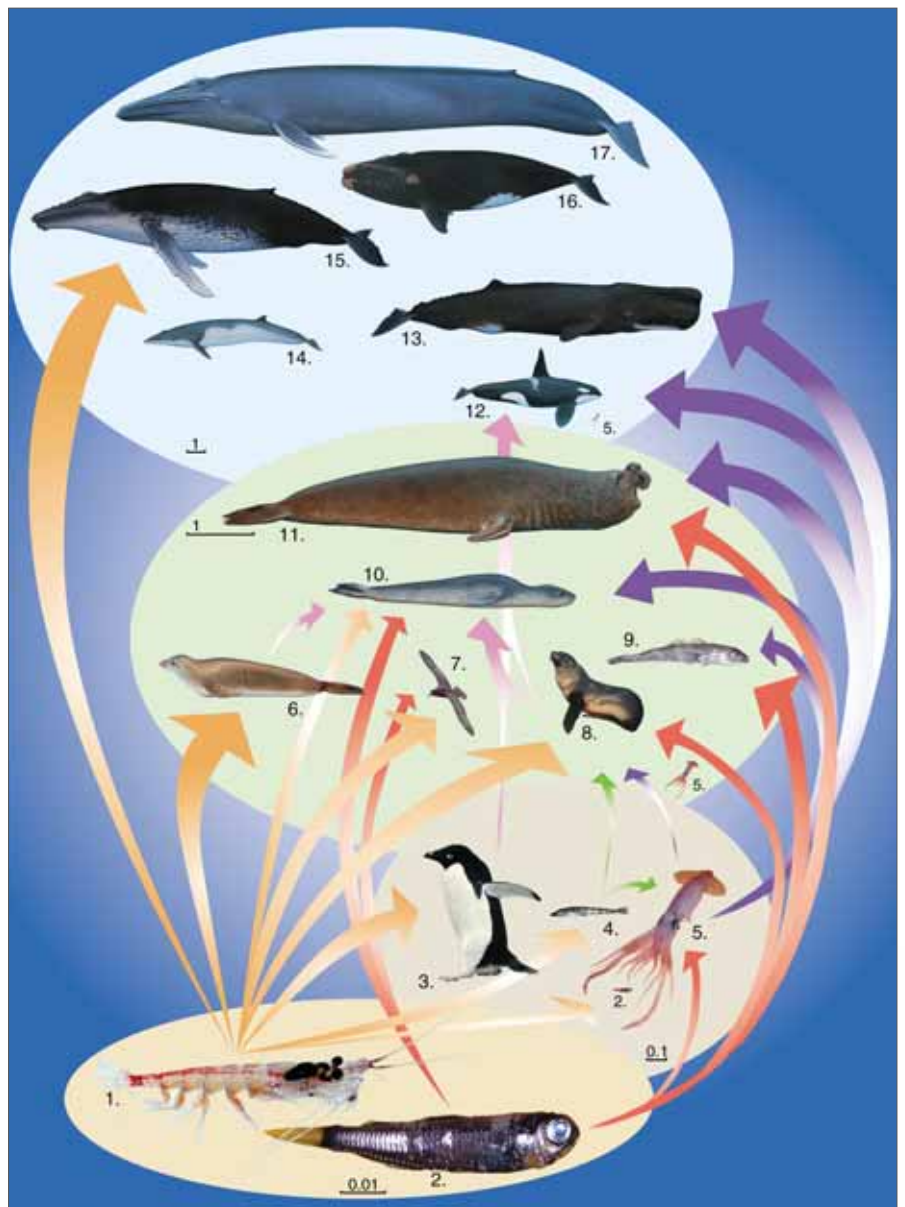

Figure 3.13. A generalised Southern Ocean food web from the level of krill upwards. Four main size groups of animals (each in a coloured ellipse) are shown. Each animal is shown to scale within each ellipse. Scale bars are present in each ellipse along with a measurement in metres showing how big the bar would be in its natural size. Squid and lantern fish are used for comparing scales between ellipses. Lower orange ellipse: (1) Antarctic krill, (2) lantern fish. Lower middle red ellipse: (2) lantern fish at new scale, (3) Adelie penguin, (4) mackerel icefish, (5) squid. Upper middle green ellipse: (5) squid at new scale, (6) crabeater seal*, (7) white-chinned petrel*, (8) Antarctic fur seal, (9) Patagonian toothfish, (10) leopard seal*, (11) southern elephant seal*. Top blue ellipse: (5) squid at new scale, (12) orca* (13) sperm whale*, (14) minke whale*, (15) humpback whale*, (16) southern right whale*, (17) blue whale*. (Source: * indicates illustrations by Brett Jarrett from Shirihai, 2007⁵⁷; Adelie penguin photo – A. Cawthorn; Other photos – A. Constable)



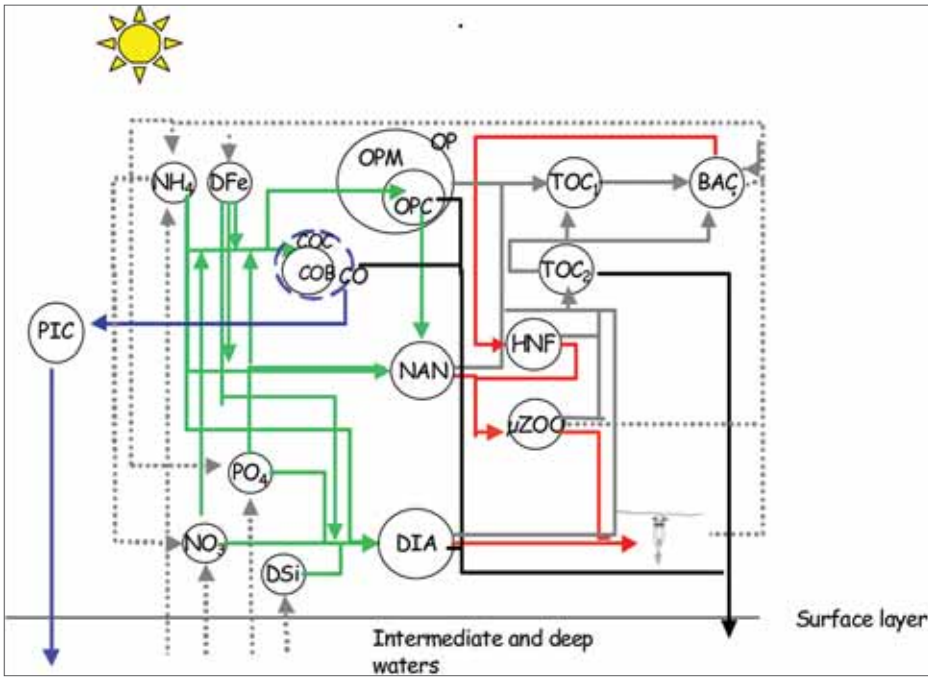

Figure 3.14. Structure of the ecosystem model SWAMCO-4, including processes (arrows) and state variables (including major nutrients NH_4 : ammonium; NO_3 : nitrate; PO_4 : phosphate; DSi : dissolved silica; and dissolved iron DFe). The model explicitly details the dynamics of 4 relevant phytoplankton groups: i) DIA: diatoms; ii) NAN: pico/nano phytoflagellate; iii) OP, OPC, OPM: Phaeocystis colony, cell, colony polysaccharide matrix; iv) CO, COB, COC: coccolithophorid cell, biomass, attached coccoliths and PIC: COC+detached coccoliths. TOC_i : fast ($i=1$) and slowly ($i=2$) biodegradable organic matter; BAC: bacteria; HNF: heterotrophic nanoflagellate; μZOO : microzooplankton. The model integrates knowledge on mechanisms controlling biological productivity and the structure of the planktonic ecosystem. (Source: Pasquer *et al.* 2005)⁵¹

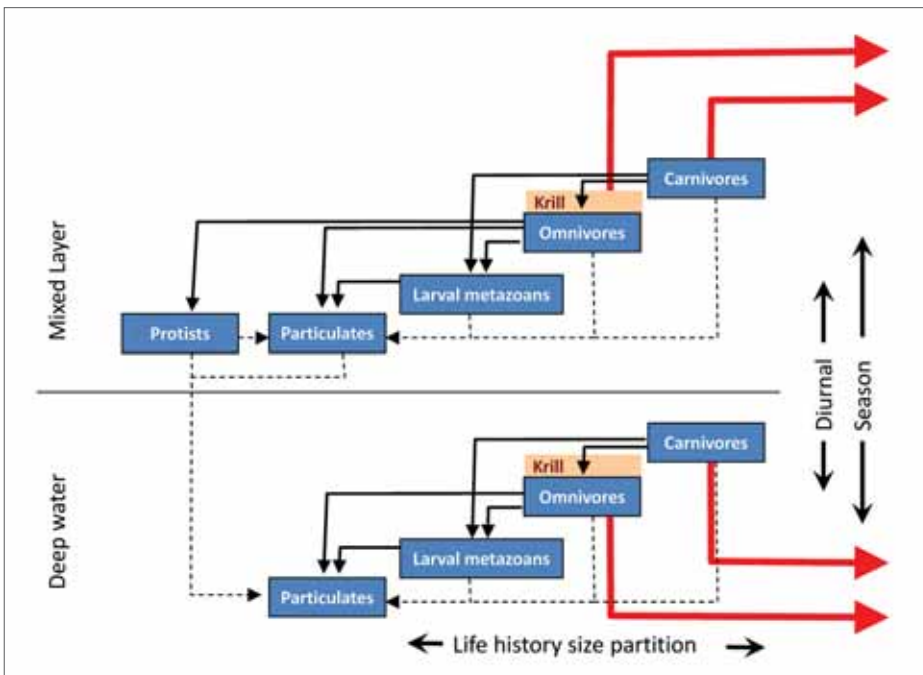

Figure 3.15. Conceptual simplified view of the lower trophic level major components and interactions in the upper mixed layer and mid ocean regions of Southern Ocean food webs (Source: Murphy *et al.*, 2009)⁴¹

Figure 3.16. Primary bioregionalisation of the Southern Ocean (Source: Grant *et al.* 2006)²⁹

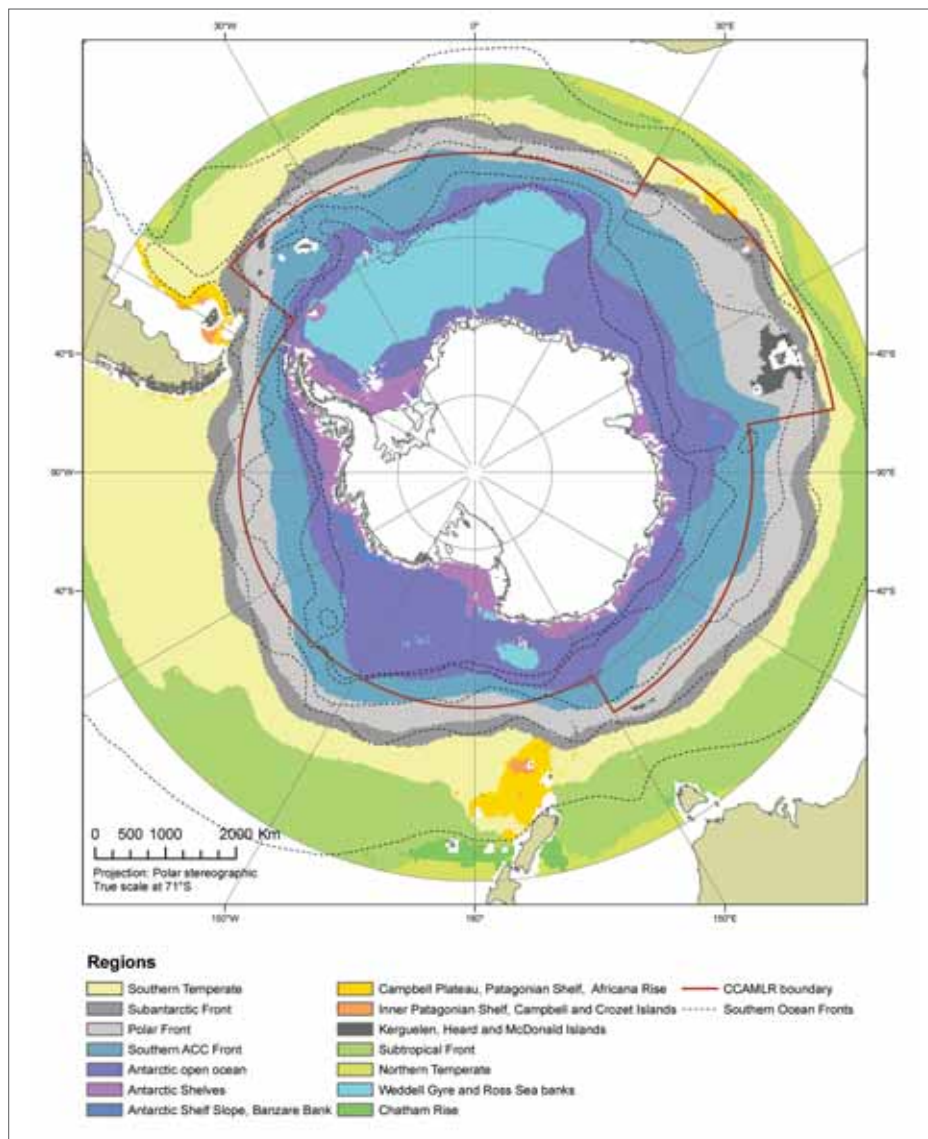
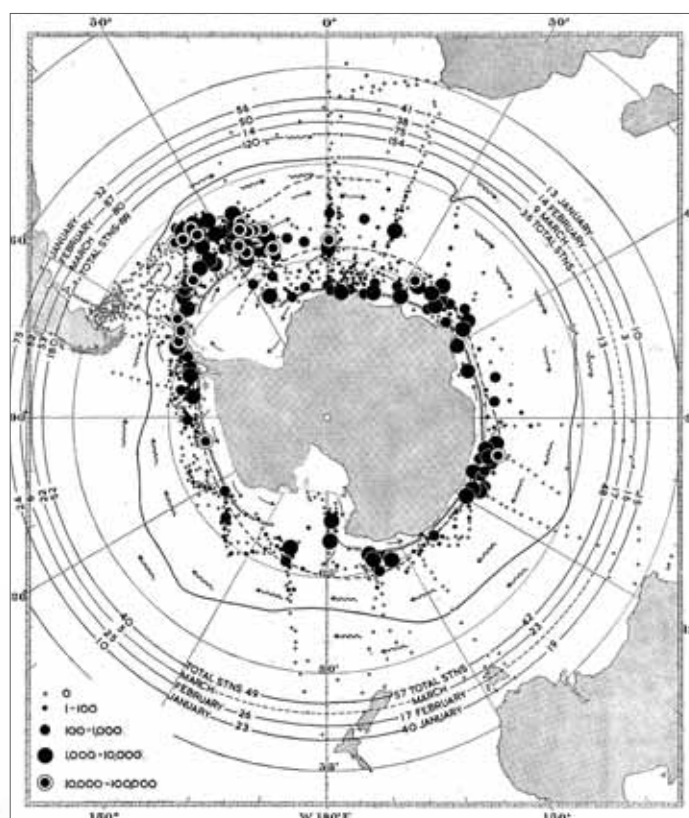

Figure 3.17. Distribution of krill in summer (Source: Marr, 1962)⁴⁰



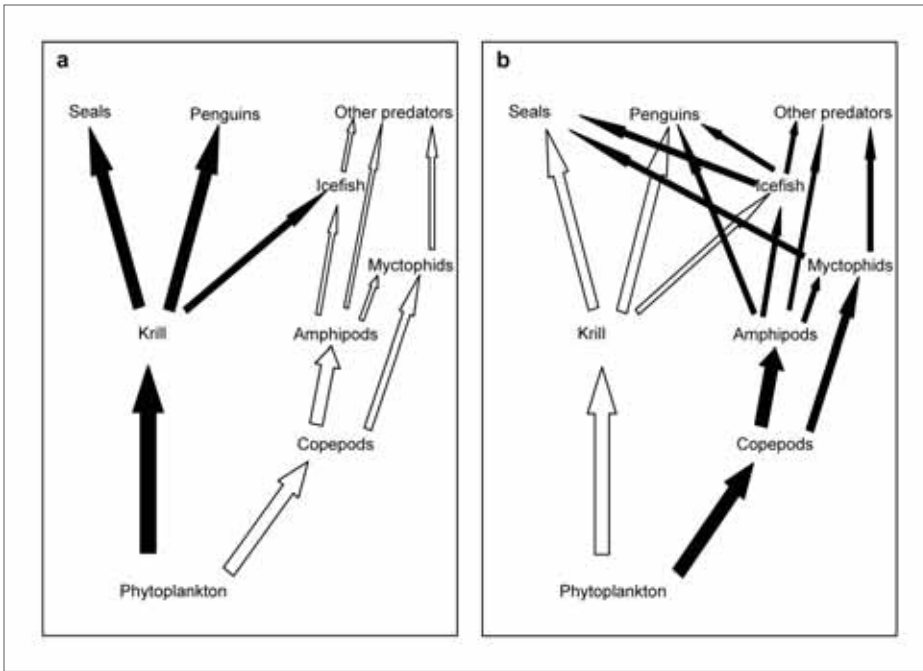

Figure 3.18. Schematic illustration of alternative pathways in part of the Scotia Sea food web, showing shifts between (a) years when krill are abundant across the Scotia Sea and (b) years when krill are scarce. Major pathways shown in black arrows. (Source: Murphy *et al.* 2007)⁴⁴.

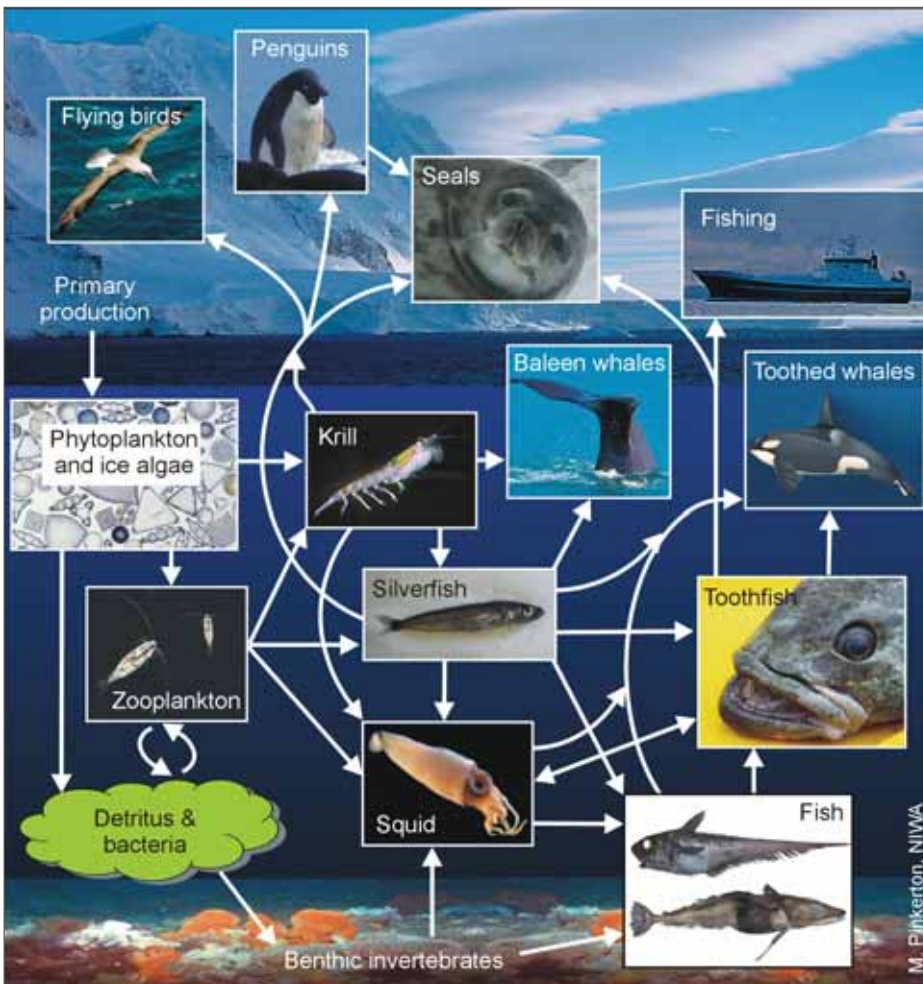

Figure 3.19. Food-web model of Ross Sea, Antarctica (New Zealand FRST project C01X0505) (Source: Pinkerton *et al.* in press)⁵³

4. Current Status, Variability And Change

The Southern Ocean has a heterogeneous suite of ecosystems that are changing. Not all changes will be due to climate change. These ecosystems have been affected over the last two hundred years by over-exploitation of marine mammals and some fish stocks. This has likely resulted in substantial change in the structure and function of the food web, most of which remains undescribed due to the lack of historical data. Changes in the physical environment have been documented, particularly during the era of satellite remote sensing since the late 1970s. Evidence of change from historical data has been increasing over the past decade and also because trends are now becoming more clearly distinguished from natural variability. This section summarises the physical and biological changes observed to date and considers the prognoses for future climate impacts on the physical system.

Many syntheses have explored the primary drivers of Southern Ocean ecosystems, focussing on the productivity of the region^{5, 6} or krill and the krill-based food web^{8, 14, 27, 39, 40, 43, 59}. The extent of sea ice is considered to play an important role for many species, particularly in the west Antarctic Peninsula region and the Scotia Sea^{40, 44}. However, identifying the combination of physical and biological drivers that have a predictable influence on the ecology of the system is difficult. This is because of the regional differences in the relative importance of the different drivers^{8, 42}, along with the difficulty of distinguishing trends from natural variability in the currently short time series of data^{7, 36, 42, 57}.

How Southern Ocean ecosystems will change in the future will be determined by the current status of the physical and biological components of the system, the ecological relationships between those components and how the important drivers of the system will change both on short and long time scales.

4.1. Changing Southern Ocean Ecosystems

Along with seasonal variability, inter-annual variability is a natural feature of the region, including variability in the Southern Annular Mode (SAM), strength of the Antarctic Circumpolar Current, maximum sea ice extent^{33, 58} and productivity¹. The combination of these factors can give rise to large variations in biomass of plankton over time, such as for krill (Figure 4.1)⁸. Recent analyses have also shown Southern Ocean ecosystem dynamics are governed by longer term and far-reaching global phenomena such as the El Nino-Southern Oscillation (ENSO) and the SAM (Figure 4.2)^{20, 32, 36}.

Interannual variability in the location of ocean fronts⁵³ and, in particular, changes in the eddy patterns that form in a given year may influence the foraging dynamics of marine mammals and birds (Figure 4.3)⁵⁴. The variability in the wind field can also lead to changes in the dynamics of sea ice (Figure 4.4)^{28, 56}. For example, the maintenance of a persistent northerly airflow over the west Antarctic Peninsula in the winter of 2005 led to a shortening of the sea ice season in the region and increased air temperature²⁹.



The relationships between sea ice extent, the biomass of krill populations and the breeding success of krill predators in the southwest Atlantic is now well documented^{36, 39}.

In the context of long-term change in the Southern Ocean, most long-term integrated ecosystem research has occurred since the 1980s. Novel analyses of pre-satellite-era data have revealed likely substantial change in ocean and sea ice habitats since the late 1940s, including an increase in mid-water ocean temperature (Figure 4.5)¹⁷ and an overall 20%-30% reduction in the extent of sea ice (Figure 4.6)^{10-12, 38}. When comparing the results of latitudinal change in sea ice extent with change in the heat content of the ocean (Figure 4.7)¹⁸, it is apparent that a rapid and significant shift in state of the physical system occurred from the late 1940s to the mid 1970s with comparatively smaller changes (variation) thereafter.

Concomitant with these changes was the sequential industrial overexploitation of many whale species in the Southern Ocean and benthic finfish (Figure 4.8)⁴². Antarctic fur seals had been nearly extirpated in the 1800s and a number of other subantarctic seal species, such as elephant seals, had been heavily exploited.

Since the late 1970s, the advent of satellite remote sensing along with other intensive field and ship-based observations have enabled significant changes to be detected, including increased winds as well as a southward shift in their location³², regional differences in sea ice extent, along with differences in the timing of its advance and retreat (Figure 4.9)^{56, 58}, abrupt loss of ice shelves²⁶, freshening of the bottom water indicating a freshening of the surface waters near to the continent⁴⁷, a southward shift in the ACC fronts⁵², along with a changed eddy field^{31, 49, 53}, and an increase in ocean acidification³⁵.

These regional changes have been accompanied by a number of changes in the dynamics of biota.

The west Antarctic Peninsula is one of three areas of the globe experiencing rapid climate change⁷. Sea ice seasons are now much shorter⁵⁵, winds, cloud cover as well as air and ocean temperatures, have increased^{7, 14}, and the biological activity has been observed to have shifted poleward, including primary production, krill and Adelie penguins (Figure 4.10). Unlike other regions, the incursion of Circumpolar Deep Water onto the shelf could be contributing to the warming of the region¹³.

In the Scotia Sea, Antarctic krill are believed to have declined in abundance since the 1980s (Figure 4.11)². The sea ice extent and season are now shorter⁵⁶, with the area likely to have experienced the greatest reduction in winter sea ice extent of all areas in the Southern Ocean since the 1950s¹². The switch from a krill-based food web to a copepod- and fish-based food web in times of low abundance of krill suggests that the latter may become more dominant in the future^{39, 51}. Also, salps have been postulated to be competitors with krill for phytoplankton when oceanic conditions displace shelf and near-shelf waters. A number of studies have highlighted how ice-dependent marine mammals and birds, notably Adelie penguins, have declined in the region and those that are not ice-adapted, e.g. the gentoo penguins, have increased⁵⁷. However, not all changes are due to environmental change. For example, albatross and petrels have been declining as a result of incidental mortality in longline fisheries in southern and temperate waters where these birds forage⁴⁸. In contrast, Antarctic fur seals have been recovering from their near extirpation since the early 1900s. Interestingly, their substantial recovery occurred from the 1950s⁵⁷ during the period of reduction in sea ice extent in the region.

In the vicinity of the Kerguelen Plateau, three main phenomena have occurred – a significant reduction in maximum sea ice extent¹², warming in the polar frontal zone¹⁸ and movement of the Polar Front to the south of Heard Island through Fawn Trough⁵². Few data are available on time trends of abundance or dynamics of populations in lower trophic levels. However, long term downward trends in the populations of marine mammals and birds in the region have been interpreted as a region-wide shift to a system with lower productivity^{24, 25, 60}. Similarly, studies of bird populations on the coast of Adélie Land have shown declines in abundance and shifts in their breeding phenology, which have been assumed to be related to climate change impacts^{3, 9, 21-23}.

The Ross Sea sector generally has the greatest productivity in the Southern Ocean¹. In the western margins and in the area towards the Balleny Islands the extent of sea ice has not changed appreciably over the last 70 years¹² and may have been increasing since the late 1970s^{56, 58}. This contrasts the other regions, perhaps making it a refuge for biota from climate change impacts. Also in contrast to other areas, the Adelie penguin has shown an increase in abundance over the 1980s⁹.

Attributing ecological change as impacts of climate change is a challenging task. To date, a number of correlations can be made between change in physical factors and population response. However, it is difficult to be able to attribute causality because results between regions and across years are variable and, in many cases, ambiguous⁴². These efforts are made more difficult when the relationships are non-linear, such as may be the case of the relationship between breeding success of Adelie penguins and sea ice¹⁵. A particularly important issue is to be able to standardise the data across studies so that the results are comparable, which has not been done for many species⁵⁰. These issues are further addressed in the next section.



4.2. Prognoses For Future Ecosystem Changes

In its fourth assessment report, the IPCC summarised the expected physical changes in the Southern Ocean (Figure 4.12), including a strengthening of the SAM and its movement south, a freshening and warming of the ocean and a slowing of the overturning circulation⁴. The prognosis for sea ice is a little less clear. Nevertheless, sea ice is expected to thin and become much less extensive (Figure 4.13) with the western margin of the Ross Sea and the Balleny Islands area predicted to be least affected over 100 years and summer sea ice being lost from the West Antarctic Peninsula and much of the Bellingshausen Sea²⁸.

In addition, increased carbon dioxide in the ocean will lead to acidification³⁰. This will be particularly acute in the Southern Ocean before any other region (Figure 4.14) and is predicted to affect benthos in shelf areas within 20 years and phytoplankton and invertebrates with aragonite and calcite shells in the mixed layer soon after (Figure 4.15)^{35,45}.

How individual biota and food webs as a whole will respond to climate change is a challenge⁷, which is being confronted by the new ICED initiative (Appendix)³⁷. The remaining sections will consider the options discussed at the Workshop on how to design an integrated monitoring and assessment program for assessing current and future climate change impacts. Necessarily, the design of the field program will need to take account of the current uncertainties in knowledge on how the Southern Ocean ecosystems will respond to climate change.

4.3. Figures

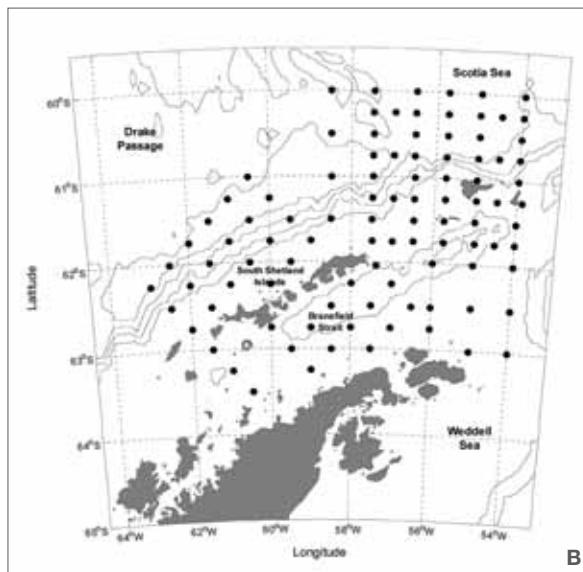
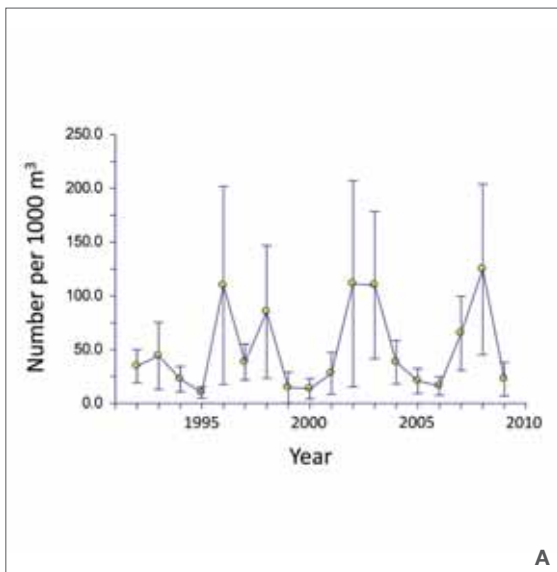

Figure 4.1. Variability in Antarctic krill in the northern Antarctic Peninsula estimated in annual surveys of the region. (a) Unweighted mean (± 2 SE) adult krill density (number of krill per 1000 m³) around the South Shetland Islands, from 1992 to 2009. (b) map showing the stations used in the annual survey. (Source: C. Reiss, unpublished data, NOAA Fisheries, Antarctic Ecosystem Research Division, 2009).

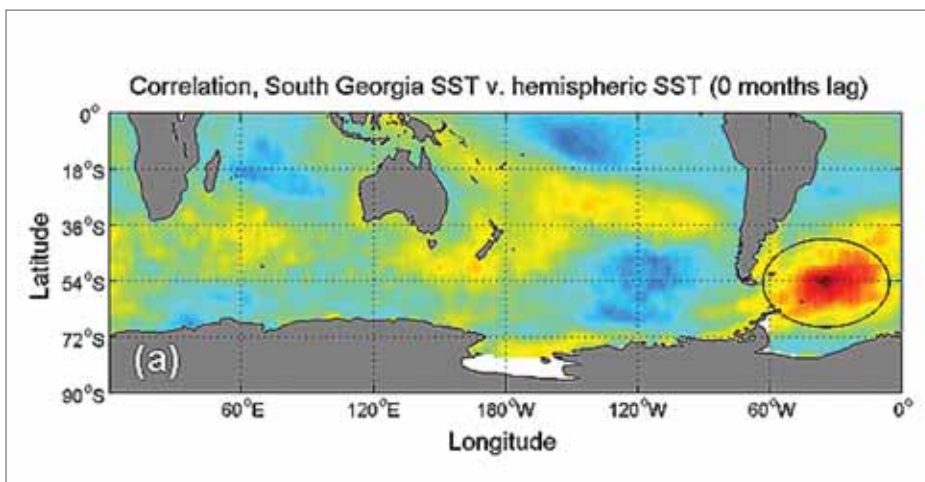

Figure 4.2. Correlation of hemispheric sea surface temperature (SST) anomalies with the SST anomalies at South Georgia (Isla Georgia del Sur) in the southwest Atlantic, showing the strong relationship between this region and the equatorial Pacific, which drives ENSO (Source: Meredith *et al.* 2008)³².

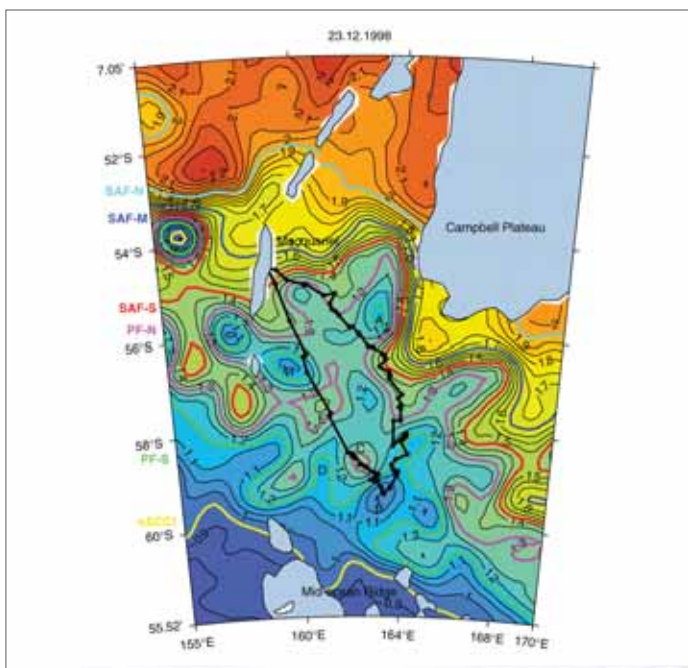

Figure 4.3. King penguin track (black solid line) in an eddy field southeast of Macquarie Island. Sea surface height (m) on 23 December 1998. The thick solid lines mark the main ACC fronts in the region. (Source: Sokolov *et al.*, 2006)⁵⁴.

Figure 4.4. Southern Ocean yearly sea ice advance anomalies for 1980 (top) and 1999 (bottom). Black contours correspond to regions showing strong trends (at the 0.01 significance level) in sea ice duration; colored contours are sea level pressure anomalies. (from Stammerjohn *et al.* 2008)⁵⁵

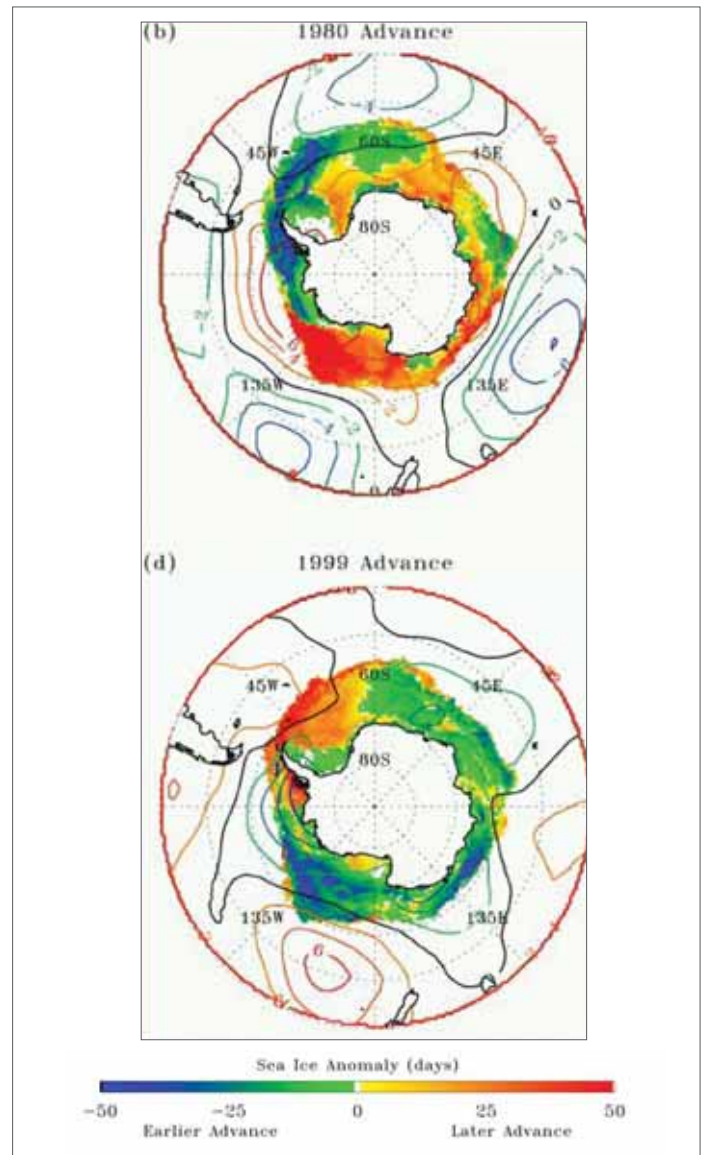
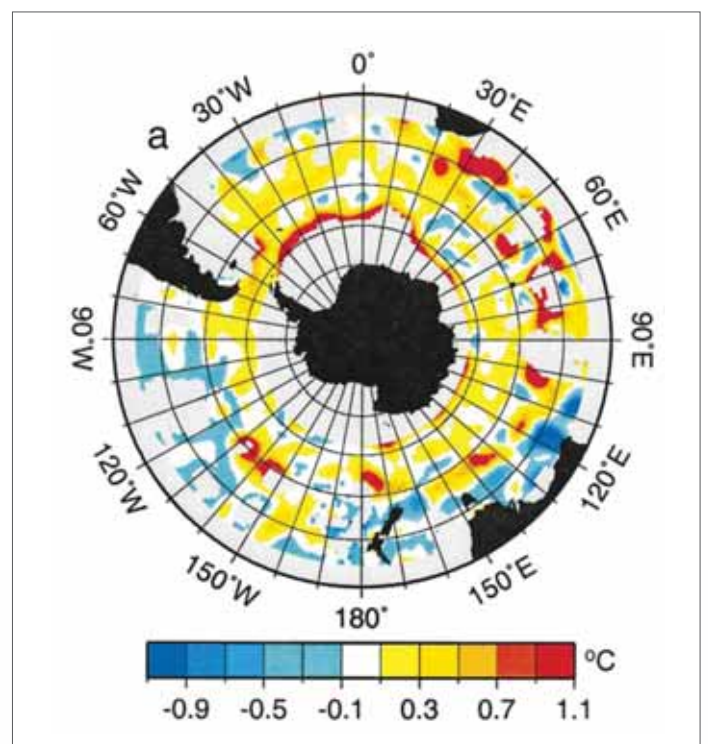

Figure 4.5. Change in ocean temperature estimated for 900 m depth between 1950s and 1990s (Source: Gille 2003)^{16, 17}



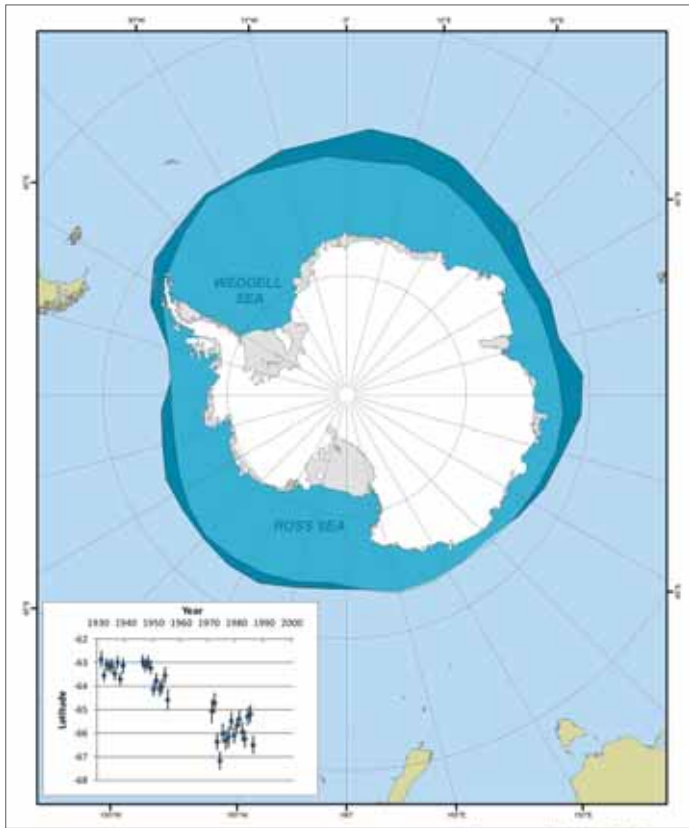

Figure 4.6. Change in sea ice extent estimated from whaling data for blue and minke whales (after de la Mare 1997, 2009)^{11, 12}. The graph shows the Latitude of sea ice extent (+ 1 standard deviation) by year standardised for 20°-30° E longitude and for 5 January each year. The map shows the Early (1931-1939) and Late (1971-1986) predicted December ice-edges.

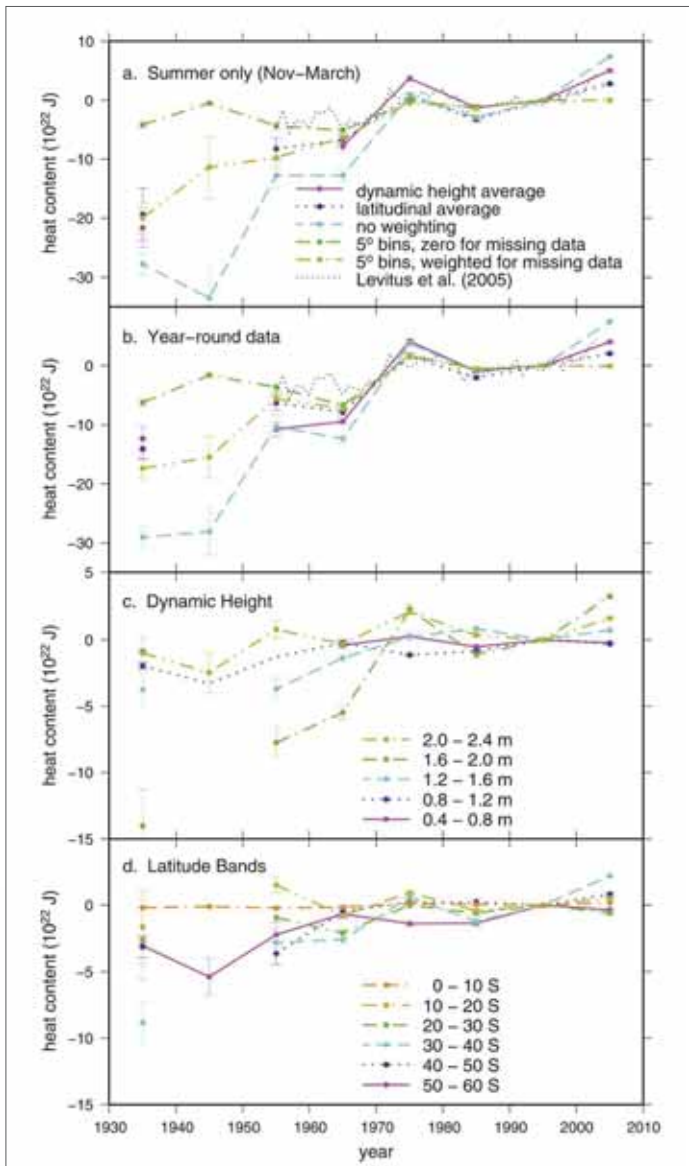
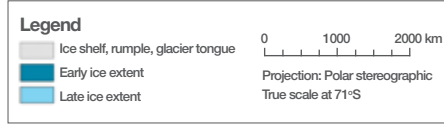

Figure 4.7. Changes in summertime (Nov-March) upper-ocean heat content (+ 2 standard errors) for top 700 m determined from differences between 1990s and historic temperature profiles using summertime only data, subdivided regionally based on latitude (Source: Gille 2008)¹⁸.

Figure 4.8. Catch of three groups of exploited biota in the Southern Ocean since 1920 (after Nicol & Robertson 2003)⁴¹. Note there was no substantial take of seals in this period.

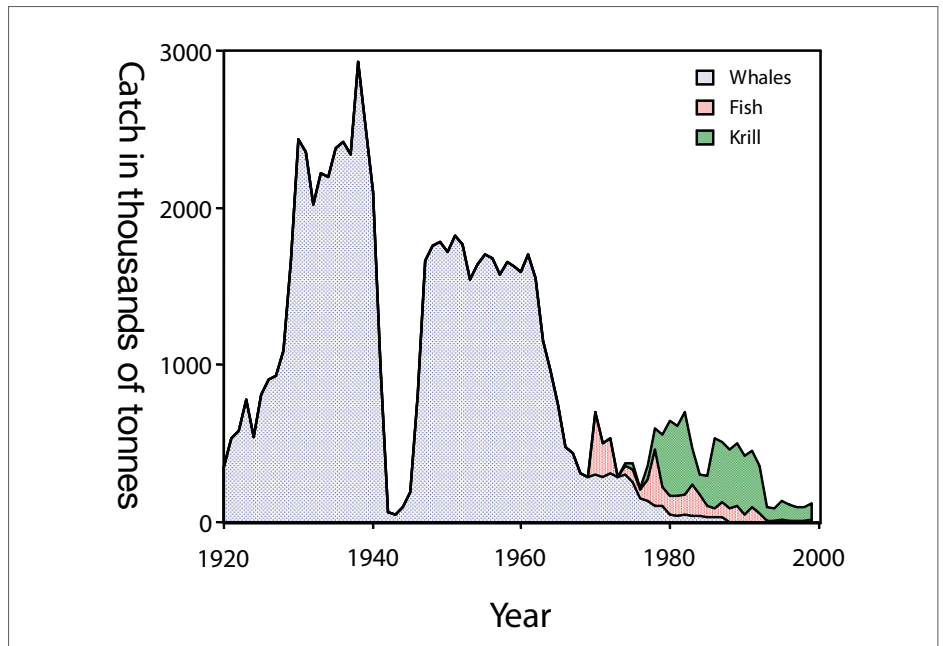
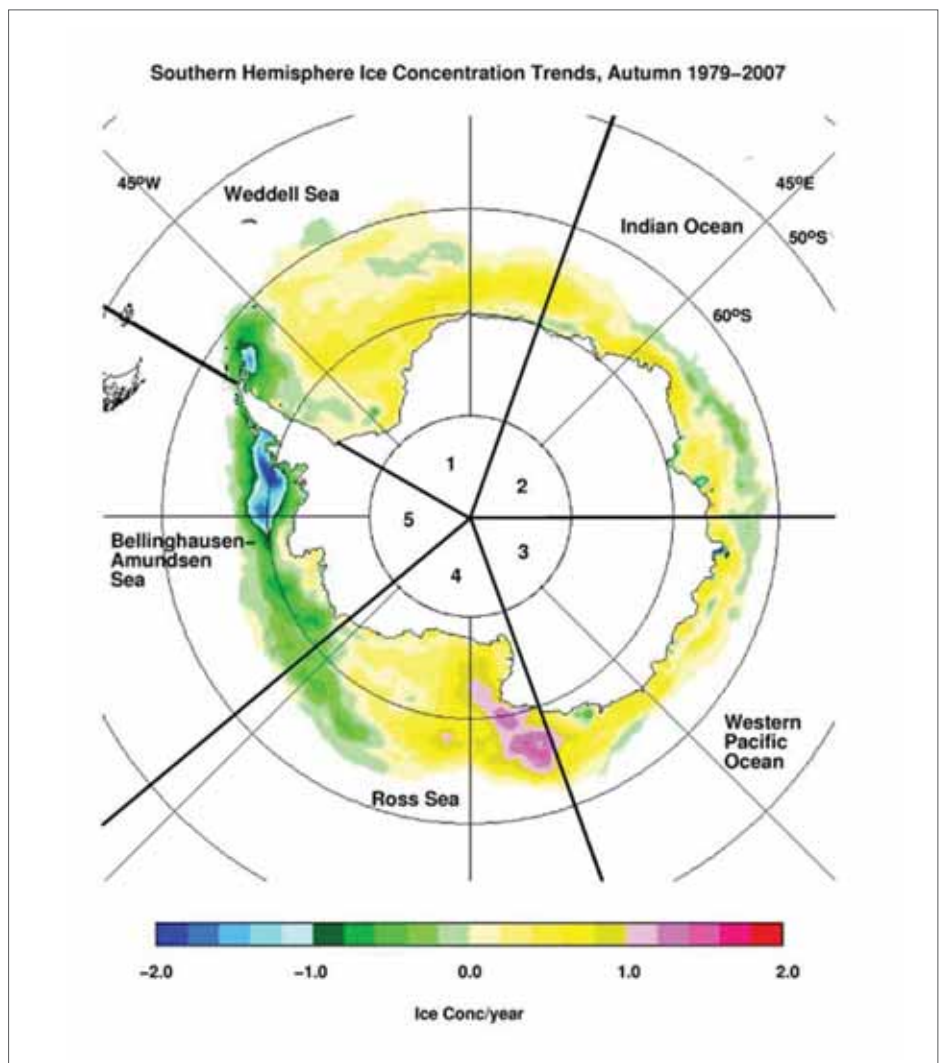

Figure 4.9. The spatial pattern of Autumn sea ice concentration changes over 1979–2007 (Source: Turner *et al.* 2009)⁵⁸



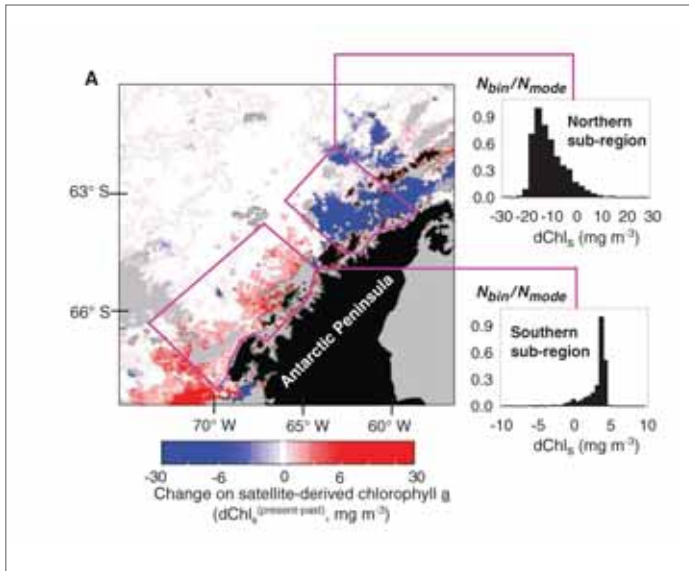
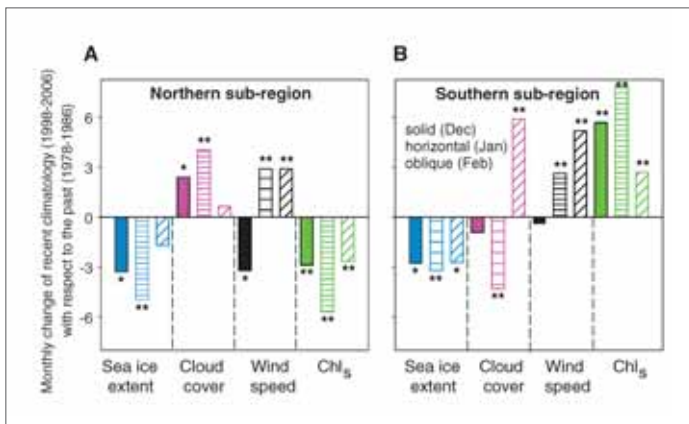

Figure 4.10. Change in phytoplankton biomass and composition over the West Antarctic Peninsula (WAP) from the period 1978 – 1986 to 1998 to 2006. (Source: Montes-Hugo *et al.* 2009)³⁴.

(a) difference in satellite-derived chlorophyll *a* concentration between the mean January observations in each period. Positive (negative) difference corresponds to an increase (decrease) of Chl_a with respect to the 1970s. Negative (by a factor of ~2, northern subregion, upper histogram) and positive (by a factor of ~1.5, southern subregion, lower histogram) trends in chlorophyll are evident in the satellite data. N_{bin}/N_{mode} is the relative frequency of observations per bin, normalized by the mode of all the data combined. Gray pixels indicate areas without data or without valid geophysical retrieval due to cloud and sea ice contamination; black pixels indicate land.



(b) Decadal variation of phytoplankton biomass and environmental factors along the WAP in the two regions in (a). Chl_a is chlorophyll *a* concentration data derived from satellites. Decadal variations (present – past) of mean Chl_a during December (solid bar), January (horizontal stripes), and February (oblique stripes). Significant differences determined using t-tests between the periods at 95% (*) and 99% (**) confidence levels are indicated.

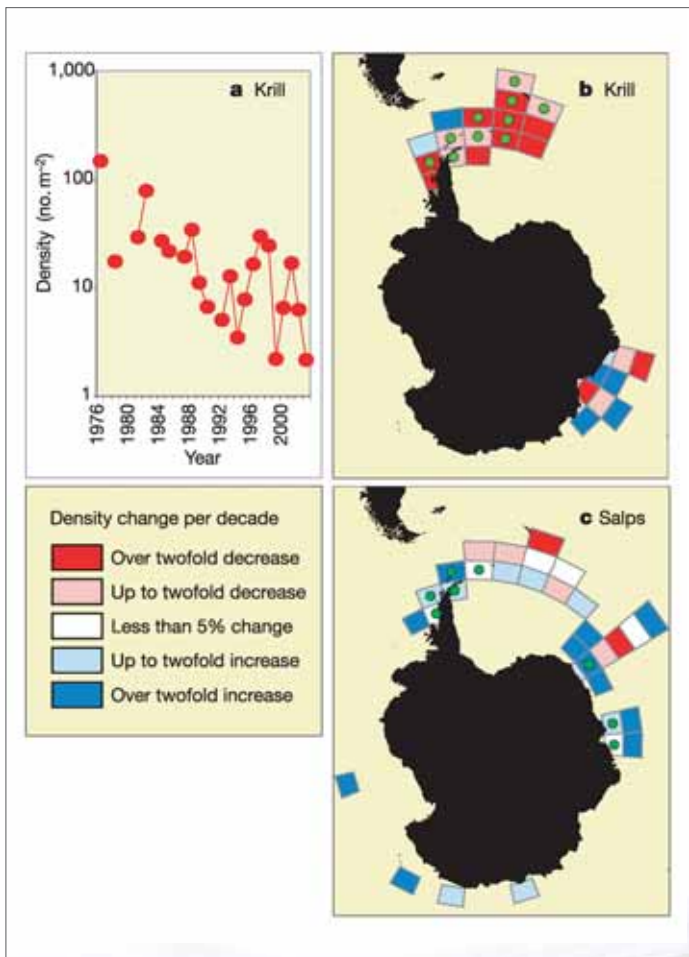

Figure 4.11. Temporal change of krill and salps. a, Krill density in the SW Atlantic sector (4, 948 stations in years with >50 stations). Temporal trends include b, post-1976 krill data from scientific trawls; c, 1926-2003 circumpolar salp data south of the SB. Regressions of \log^{10} (mean no. m^{-2}) on year were calculated for cells with ≥ 3 yr of data, weighted by number of stations in that year. (Reprinted by permission from Macmillan Publishers Ltd: Nature (Atkinson *et al.* 2004), copyright 2004, <http://www.nature.com/index.html>).

Figure 4.12. Schematic of the observed changes in the ocean state, including ocean temperature, ocean salinity, sea level, sea ice and biogeochemical cycles. The legend identifies the direction of the changes in these variables. (Source: Bindoff *et al.*, 2007)⁴.

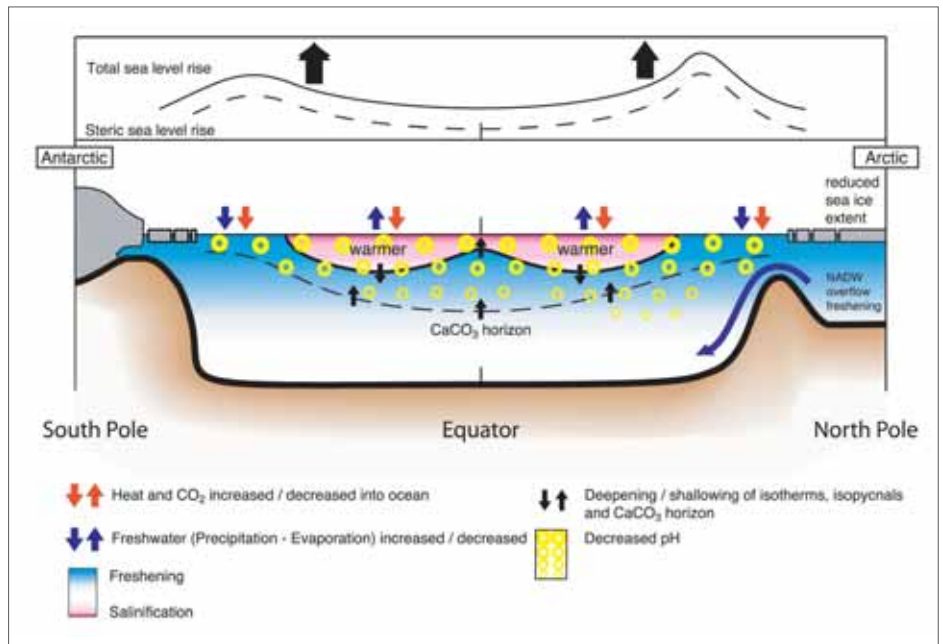
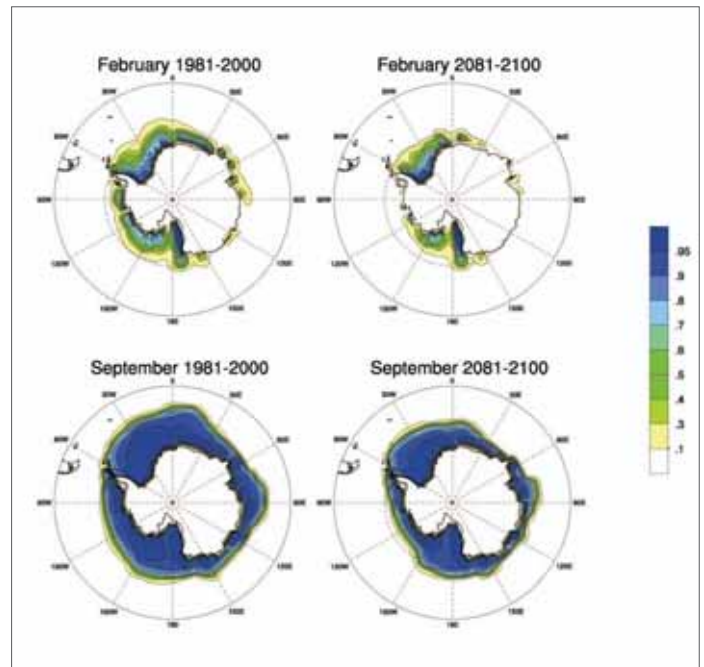

Figure 4.13. Modelled ice concentration in the CSIRO Mk3.5 SRESA1B (mid-range) scenario for the periods 1981-2000 and 2081-2100. From Massom *et al.* (in prep.)²⁸



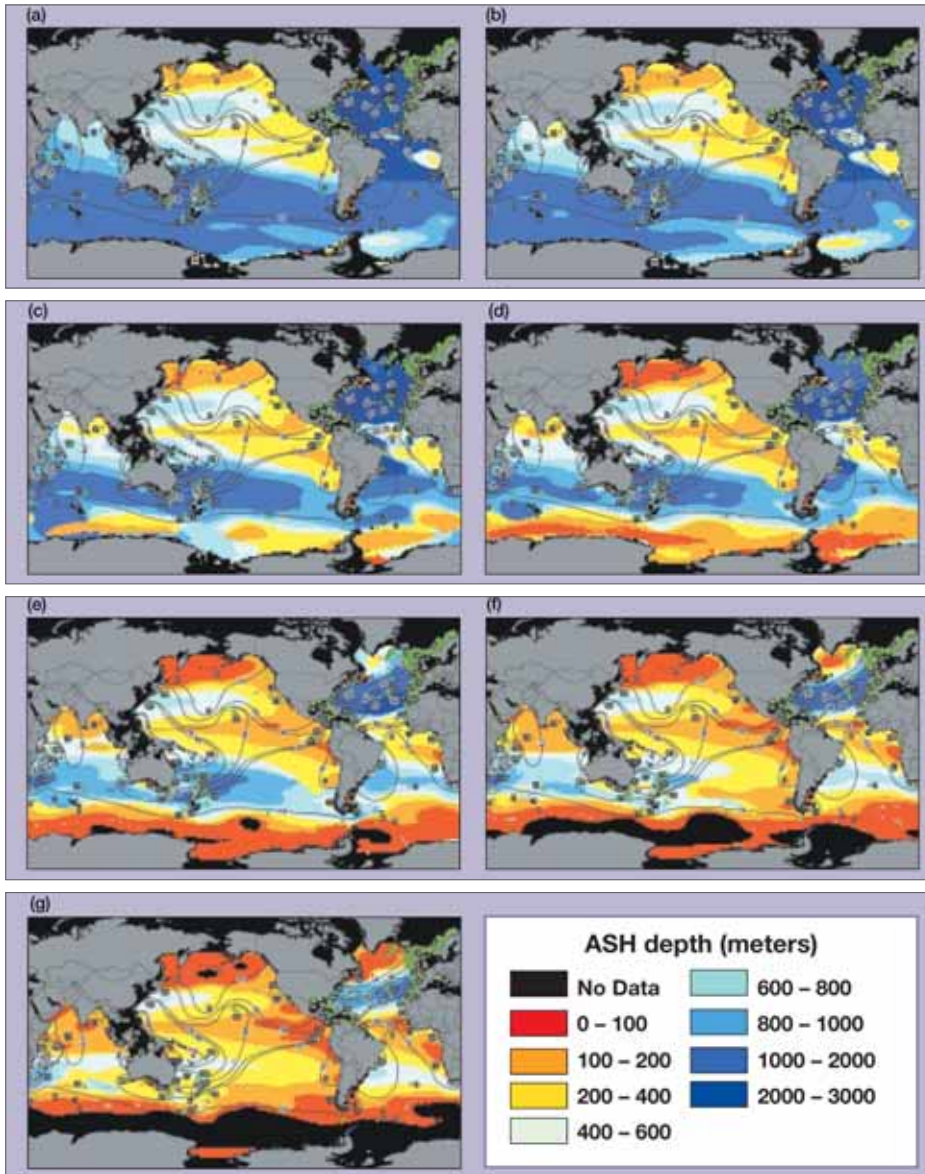

Figure 4.14. Depth of the aragonite saturation horizon (ASH), locations of deep-sea bioherm-forming corals, and diversity contours for 706 species of azooxanthellate corals. (a) Projected ASH depth for year 1765; $p\text{CO}_2=278$ ppmv. (b) Estimated ASH depth for year 1995; $p\text{CO}_2=365$ ppmv. (c) Projected ASH depth for year 2020; $p\text{CO}_2=440$ ppmv. (d) Projected ASH depth for year 2040; $p\text{CO}_2=513$ ppmv. (e) Projected ASH depth for year 2060; $p\text{CO}_2=594$ ppmv. (f) Projected ASH depth for year 2080; $p\text{CO}_2=684$ ppmv. (g) Projected ASH depth for year 2099; $p\text{CO}_2=788$ ppmv. Black areas appearing in the Southern Ocean in figures 1e–g and the North Pacific in Figure 1g indicate areas where ASH depth has reached the surface. (Source: Guinotte *et al*, 2006)¹⁹

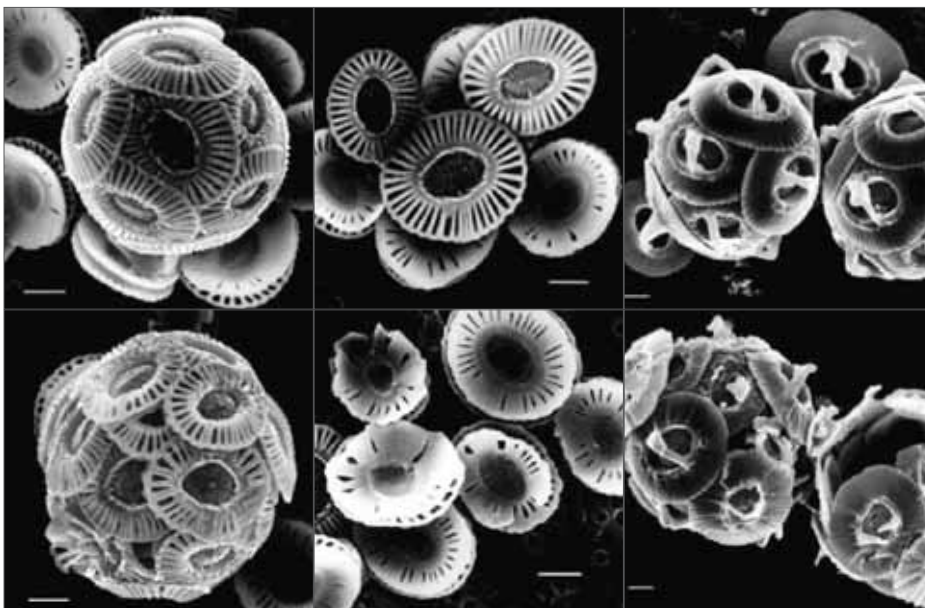

Figure 4.15. Scanning electron microscopy (SEM) photographs of coccolithophorids under different CO_2 concentrations. a, b, d, e, *Emiliania huxleyi*; and c, f, *Gephyrocapsa oceanica* collected from cultures incubated at $[\text{CO}_2] \sim 12 \mu\text{mol l}^{-1}$ (a–c) and at $[\text{CO}_2] \sim 30\text{--}33 \mu\text{mol l}^{-1}$ (d–f), corresponding to p_{CO_2} levels of about 300 p.p.m.v. and 780–850 p.p.m.v., respectively. Scale bars represent $1 \mu\text{m}$. Note the difference in the coccolith structure (including distinct malformations) and in the degree of calcification of cells grown at normal and elevated CO_2 levels. (Reprinted by permission from Macmillan Publishers Ltd: Nature (Riebesell *et al*. 2000), copyright 2000, <http://www.nature.com/index.html>).

5. Assessing Climate Change Impacts

An assessment of climate change impacts on Southern Ocean ecosystems and biodiversity requires measurements of change in an ecosystem and then attribution of that change to climate change. Field programs need to be designed in such a way that they can discriminate climate change impacts from natural spatial and temporal variation or other causes of change, such as fisheries. The method of attribution will need to be capable of rejecting alternative hypotheses that might explain the observed change. Other ecosystem data may be required for this purpose. This section considers approaches for identifying plausible scenarios of climate change impacts, choosing a set of indicators of those impacts, designing programs to monitor the indicators, and attributing observed changes to climate change.

Marine biodiversity could be impacted by climate change through evolution and adaptation (genotypic response), alteration of the distribution or dynamics of species (population/species-specific response), or change in the structure and functions of ecosystems, which may include change in habitats or how species may be able to interact with each other and with the physical environment (ecosystemic response). In general, the types of impacts to be assessed need to be determined in order to be able to design a monitoring program that can be used directly in assessments while keeping within the bounds of resources available for the task.

A monitoring program, as repeated observations over time, can derive a number of benefits including detecting predicted outcomes or trends or to detect phenomena outside of normal experience that will

need to be included in assessments. Both of these benefits are important to consider in designing a monitoring program. In the case of detecting new phenomena low level monitoring may be all that is needed until such time as important phenomena are indicated, at which time the effort in their measurement may be increased. Such phenomena might include invasions by species not normally found in the region or regime shifts.

Section 4 highlighted that change is occurring now and that significant change is expected within the next 20 years, particularly with respect to ocean acidification. A monitoring program to assess the impacts of these changes will need to be long term. It will also need to be adaptive to ensure the suite of indicators is updated to replace indicators that become insensitive to those changes. In the long term, a monitoring program will also need to be updated to account for new knowledge, insights and predictions as well as to take advantage of new technologies and approaches.

A monitoring program will, therefore, be an evolving set of field programs with long periods of monitoring some indicators, shorter term campaigns for collecting more detailed data and, perhaps, shifts in emphasis in the monitoring program over time. The shifts in monitoring may need to occur in order to ensure the monitoring is continually relevant to predicting the impacts of climate change.

The important steps in designing a long term monitoring program are well established. Downes *et al.*¹⁰ provide a useful recent review and discussion of the principles and issues for designing monitoring programs to detect impacts. In the specific case of the Southern Ocean Sentinel, those steps should include the identification of possible future climate change impacts on marine biodiversity, the selection of appropriate indicators of those impacts if they arise, the spatial and temporal requirements of monitoring to distinguish climate change impacts from natural variation, which will at least require multiple locations to remove confounding factors, a baseline period before substantial change is expected to arise, and the use of appropriate analytical methods for attributing and estimating climate change impacts.

5.1. Building Plausible Scenarios of Current and Future Impacts

Plausible scenarios will represent the linkages between climate change, physical processes and ecological dynamics as well as their variability in space and time. The earlier sections of this report consider the types of linkages that may be present in the Southern Ocean. Possible impacts could be identified by using conceptual models, which are important for developing a common understanding of ecosystem structure and dynamics³⁰, direct-effect risk assessment models and/or more complex feedback models^{6, 8, 13, 24}. The approaches considered at the Workshop are described here along with some of the issues that remain to be resolved in developing predictive models.

5.1.1. Species-Specific Impacts

Species-specific responses to climate change impacts could include a direct response, acclimation in the short term (the response is tempered by the species ability to accommodate change) or adaptation in the longer term (some phenotypes cannot cope with the change and natural selection occurs). Responses could include changes in distribution, patterns of movement, population density and dynamics, phenology (timing of key processes during the year), interactions with other species, and morphology or physiology^{3, 31}. These inevitably include direct and indirect impacts of climate change. In the same way that Andrewartha & Birch¹ envisioned the use of envirograms (Section 3), expert knowledge could be used to identify the likely qualitative direction of each of these responses, if any, under different plausible scenarios of climate change impacts on the physical system.

The Workshop illustrated this approach with some examples. A preliminary analysis, based on expert judgement, of expected responses by five different taxa from the Southern Ocean to change in a number of physical conditions in the region is shown in Figure 5.1. The process was further refined for emperor penguins to explore where in the life cycle or during a year that a species might be most vulnerable. An adult emperor penguin spends its time breeding on fast

ice during winter-spring and foraging at sea during summer. Figure 5.2 illustrates the response of the emperor penguin at different stages in its annual cycle to changes in the physical factors.

At a glance, this risk-assessment approach can show how species may respond directly to changes in physical parameters or other interactions, particularly when some ecosystem components may have different pathways to impact on a species (Figure 3.13). Gaps in knowledge or uncertainty in the outcomes can also be identified.

5.1.2. Ecological Impacts

The combined species-specific responses could result in shifts in the structure and function of marine ecosystems¹⁶. The Workshop identified three main classes of ecological impacts that might arise – energy flows & nutrient cycling, habitats, and food webs. An example of the first case is where the succession of phytoplankton taxa during the spring bloom may alter, thereby altering the dynamics of primary and secondary production².

Changes in habitats could arise if habitat-forming species, such as corals¹⁵, or habitat engineers, such as bioturbators, are impacted. Similarly, changes in conditions could alter the succession of species in an area (pelagic or benthic). For example, species formerly inhibited from occupying an area may be able to colonise the area. Conversely, those requiring other species to be present before colonising an area may find it more difficult to successfully colonise if those ‘advance colonisers’ are no longer present. Many biota alter the environment, which may in turn regulate future conditions. Such alterations could give rise to larger scale feedbacks, positive or negative, which could have region-wide effects. An example of this is the production of dimethyl-sulphide (DMS) by phytoplankton can give rise to increased cloud cover, thereby reducing the amount of light in the area available for photosynthesis^{4,32}.

In the case of food webs, direct and indirect impacts on species may give rise to shifts in food web structure and function. These have been well described in Sections 3 and 4.

Complex direct and indirect interactions could result in some species experiencing both positive and negative impacts. For example, some species recovering from over-exploitation or some other perturbation may not change in abundance under some climate change scenarios. Under these circumstances, these species could not be used in a monitoring program as no change is usually regarded as no impact. Model representations of the system are needed that satisfactorily represent the key interactions and the potential for positive and negative feedbacks.

5.1.3. Predicting Impacts

Predictions are made on the basis of models, which could be conceptual, statistical^{11,12}, qualitative^{7,8} or quantitative²⁴ and need not be complex to be used successfully¹³. A model is adequate (‘high skill’) if it correctly represents the important processes and likely behaviour of the subject species and ecosystems. ‘End-to-end’ models will be required for predicting climate change impacts because of the need to represent the physical processes (atmosphere-ocean-ice models), the productivity of the region (biogeochemical models) and the dynamics of species (food web and habitat models) (Figure 5.3)^{24,25}. An international collaboration on the development of these models is underway through ICED²⁴.

Biogeochemical models (Figure 3.15) are being developed as part of Earth System models^{23,26,28}. They investigate the sequestration of carbon from the atmosphere by phytoplankton and the potential for this process to be a negative feedback to climate change. At present, these models do not represent well the variability in mortality of phytoplankton, which is a consequence of the variability in the dynamics of higher trophic levels in the food web (Figure 5.4).

Southern Ocean food web models (Figures 3.19, 3.20), on the other hand, do not represent very well the links to physical ocean models or the dynamics at lower trophic levels^{5,18,29}. Also, many parameters that influence the relationships between higher trophic predators and their prey are poorly understood (Figure 5.4)³⁰, including the ability of predators to find and capture food when their prey is in low abundance, and the degree to which those predators can survive or delay reproduction during those periods. Some

key uncertainties in food web models are the role that mesopelagic fish and squid may play in food webs, the dynamics of the food web in winter and estimates of total primary production for the region³⁰. Also, benthic systems are poorly understood in the Southern Ocean.

Predictions will need to account for these model uncertainties. Conversely, the alternative plausible models can be used to design the field programs, i.e. to identify what time-series of data or estimates of parameters would be needed to help identify which models are more likely to be correct. Surrogate measures may be needed in cases where the component to be predicted or to be used for discriminating between models cannot be measured, e.g. squid abundance.

Abrupt change is difficult to represent in models and pose a challenge for making predictions. These ‘vampires in the closet’ could include outbreaks of disease, invasive species arriving, or regime shifts. An important question is whether some variables could be monitored to signal when these abrupt changes might occur.

The models would be evaluated at appropriate intervals in the field work. This would allow inappropriate models to be rejected, new models to be erected if needed and existing models to be modified. The updated ensemble of models can then be used to refine the field program in order for it to remain appropriate for testing the models and reducing the uncertainties in their predictions. This is a process similar to the iterative process of the IPCC.

5.2. Choosing A Set Of Indicators

Measurements of components of the ecosystem will be used in assessments of climate change impacts. Predictions are tested by comparing the measurements to the predictions. For the Southern Ocean Sentinel, the quality of assessments of future climate change impacts will also be dependent on the degree to which models can be corroborated or refuted. Indicators are therefore chosen either to signal the state of particular components of the ecosystem (structural indicators) or to determine if ecosystem dynamics (process indicators) are suitably represented in models for correctly predicting ecosystem dynamics under future, as yet untested, climate change.

The choice of indicators will be dependent on the sampling design of the monitoring program, which is considered below. Some indicators may have coarse biological resolution in what they are measuring but are monitored easily and cheaply with the intent of signalling when more detailed sampling might be undertaken. For example, satellite remote sensing data may be sufficient to signal when surface primary production may be changing. Such a signal may then initiate a more comprehensive at-sea field program, say, to investigate whether the total primary production in the water column has changed and how zooplankton and other species may have responded. While this will save resources in the long term compared to a regular comprehensive program, it will be more reactive and will require a guarantee of resources for when the more detailed requirements are triggered.

Specifically, a good indicator will be easily measured and understood, cost effective, sensitive to the drivers of interest and based on an understandable relationship to the ecosystem, and easily communicable^{5,14}. A suite of indicators would be best for understanding ecosystem responses to climate change. They would be chosen to range across the different spatial and temporal scales of the ecosystem. Regularly sampling everywhere need not be required because species could be chosen that effectively integrate across those scales. For indicators to signal imminent or future

change they may need to measure sub-lethal characteristics of species in order to give sufficient warning.

Structural indicators may be based on relative abundances of taxa or functional groups (ecologically similar taxa). Process indicators would ideally reflect combined or multivariate quantities^{9,10,14,20}, such as ratios of different functional groups (e.g. ratio of piscivores to herbivores or pelagic to demersal), size spectra, overlaps in occurrence of species with habitats, and rates of different processes. Emerging technologies may provide other useful integrative indicators, such as the use of genetic analyses in understanding food web linkages and the use of metagenomic probes for monitoring general diversity.

While simple indicators are recommended, an important criterion for the Southern Ocean Sentinel is that they are sensitive to climate change impacts. Choosing a suite of indicators is not an easy process²⁷, particularly with the complexity of direct and indirect effects described above. Figure 5.5 shows the types of methods considered at the Workshop that could be used to identify ecological indicators¹⁷. Process models will be needed to evaluate indicators because of positive and negative feedbacks in Southern Ocean ecosystems.

Risk assessment approaches can be integrated into a network analysis of interactions using qualitative process modelling^{7,8}. Figure 5.6 shows how such a network could be developed by using an illustrative case of a simple krill-based food web. In this approach, simple press (prolonged) disturbances can be applied to any particular component to see which other components may be affected along with the direction of the effect.

The table of results developed at the Workshop, also shown in the figure, shows how contrasting indicators can be revealed in this type of analysis. For example, krill and fish show similar responses to each other for an increase in the krill fishery and for an increase in sea ice. In contrast, copepods and salps have different responses to krill and fish as well as different responses to each other. These four taxa offer a potential set of contrasts that could be used when trying to attribute ecosystem changes to either climate



change impacts or to fishing. Such monitoring would be more powerful for distinguishing the effects of fishing from climate change impacts if all four indicators are monitored in areas with fishing and without fishing. Emperor penguins may be useful to monitor in this context. The other taxa have either confounded results or are likely not to be able to be monitored.

More detailed dynamic models may need to be used to further evaluate the potential indicators in order to be confident of the outcomes of the qualitative analysis. Nevertheless, the use of qualitative models provides a rapid way of assembling expert knowledge and for determining where further investigations should be made in developing the suite of indicators.



5.3. Designing Monitoring Programs

Chosen indicators will need to be measured in such a way (where, when and how many) to be confident their estimated value represents the status of the indicators in reality⁵. Further, the spatial and temporal scales of the estimates need to match the scales of their intended use in the assessment. In other words, if the predicted value of the indicator is for the whole of the Southern Ocean then many measurements of the indicator should be taken across the whole of the region in order to take account of the likely smaller-scale spatial variability in the region.

The process for designing a field monitoring program is well described in the literature¹⁰. If the monitoring program is well designed, changes in the indicator will be correctly attributed to the cause. If not, the change may be attributed to climate change impacts when it may simply have been a difference between, say, two areas (e.g. if the different sampling events were in two separate places) or, say, two times (e.g. if one sampling event was at a high point in a natural cycle and the other event was at a low point). As a general rule, the number of samples required will be correlated with the magnitude of variability and should be sufficient to have a high statistical power in rejecting the null hypothesis (no change) when there is change. An approach to reduce the research effort required is to relax the evidence required for concluding impacts have occurred²².

A difficulty for attributing change in the Southern Ocean to climate change is that no area will be immune. Nevertheless, the regional differences in impacts of climate change on the physical environment (west Antarctic Peninsula, southwest Atlantic, southwest Pacific and southern Indian Ocean – Section 3) could be used as a natural experiment for contrasting different models about ecosystem structure and function and the relative impacts of climate change³¹.

5.4. Attributing Change to Climate Change

Models will be needed to test whether observed change in the indicators can be attributed to climate change¹². An assessment will need to account for measurement error, natural variability and uncertainty in the structure of the models used in the assessment¹⁹. A number of contrasting types of evidence may be required before attribution can occur, which could include the use of a number of plausible models based on the same data or comparative analyses of different datasets²¹. The ability to use results from different, contrasting regions will be a great advantage in attributing climate change impacts.

A time series of observations could become confounded by factors other than climate change if steps are not taken to protect the integrity of the monitoring in the long term. These factors could include fisheries, tourism, operations or other activities not yet present in Antarctica. Climate change reference areas may be needed so that the time series is not impacted inadvertently by those activities. The spatial configuration of such areas will be dependent on the types of field data required for developing models (field experimental work and parameter estimation) and for the regular measurement of indicators.

5.5. Figures

Figure 5.1. Expected qualitative direct impacts of change in seven different physical processes on populations of five different taxa in the Southern Ocean. Arrows indicate qualitative direction of change.

Change	Direction of Change	Direction of Reaction				
		Calcified Phytoplankton	Krill	Icefish	Emperor Penguin	Crabeater Seal
Air Temperature	↑	-	-	-	↑	↑
Water Temperature	↑	↑	↑	↑ ↓	↑	↑
Acidification	↑	↓	↓	?	-	-
Sea ice	↓	-	↓	-	↓	↓
Currents	↑	↑ ↓	↑ ↓	↑	?	?
Wind	↑	↓	↓	?	↓	↓
Snow and Rain	↑	-	-	-	↓	↓

Figure 5.2. Expected qualitative direct impacts of change in seven different physical processes on adult Emperor penguins at different stages of their annual cycle. Arrows indicate qualitative direction of change.

Change	Direction of Change	Direction of Reaction – Emperor Penguin		
		Breeding	Chick Rearing	Foraging
Air Temperature	↑	-	-	-
Water Temperature	↑	-	-	↑
Acidification	↑	-	-	-
Sea ice	↓	↓	↓	↓ ↑
Currents	↑	-	-	↑
Wind	↑	↓	↓	?
Snow and Rain	↑	↓	↓	-

Figure 5.3. Producing coupled models of ecosystem operation requires the development of models encompassing different temporal and spatial scales. At different scales the biological processes and trophic resolution included will vary and depend on the main scientific issues being addressed. A major challenge is to develop the appropriate links between different types of models that resolve different biological processes, and apply these at different scales. (Murphy *et al.* 2007, 2009)^{24, 25}

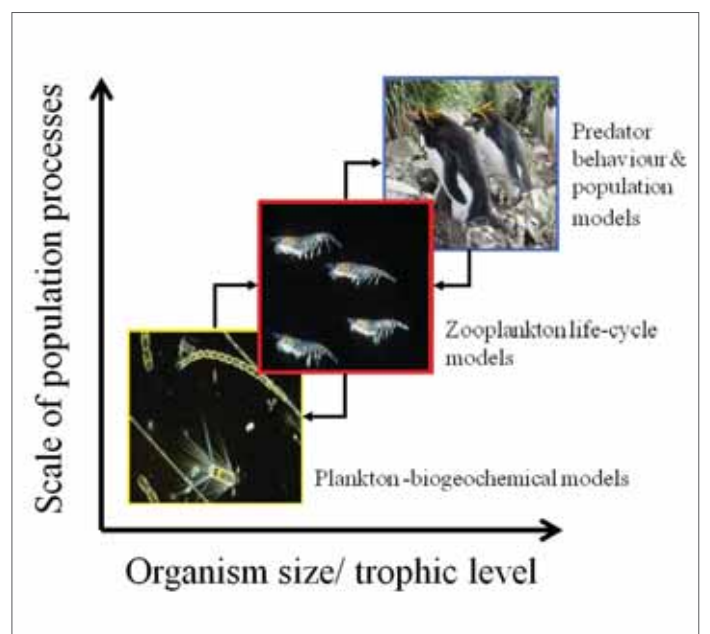

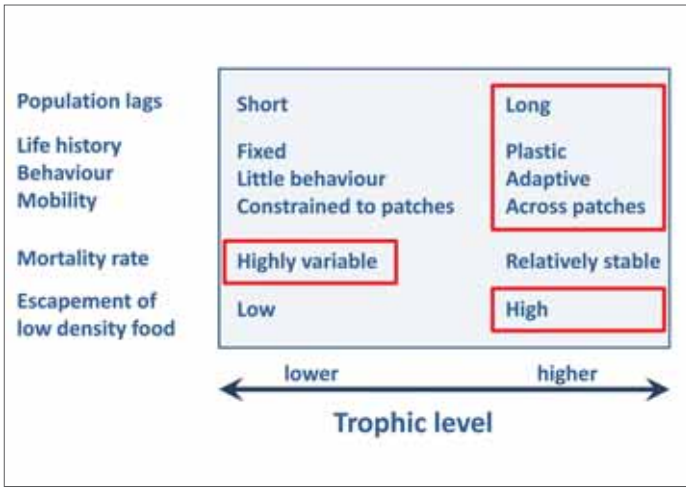

Figure 5.4. Summary attributes of the dynamics and food web linkages of species in the lower (e.g. protists) and upper (e.g. seals) trophic levels. Population lags are the time between when food is consumed and an appreciable change in biomass of the population might occur through reproduction. Life histories are the life cycle of a species combined with the ability to vary (plasticity) reproductive events over the course of their life. Mortality rate is the probability of dying at any given time. Escapement of low density food relates to the likelihood that the prey of a species will not be consumed when the prey is at low densities. The red boxes indicate parameters that are not well known.

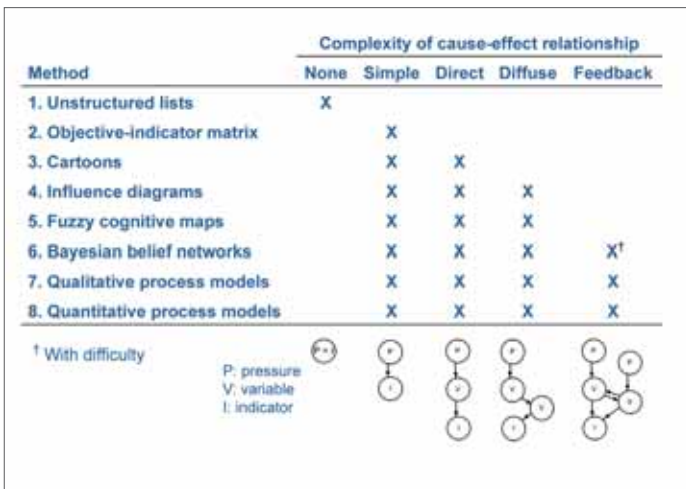

Figure 5.5. Sufficient methodologies for identifying ecological indicators (Hayes *et al.* 2008)¹⁷. Pressure is the external pressure applied to the system, such as climate change. A variable is a component of the system. The indicator is what is measured.

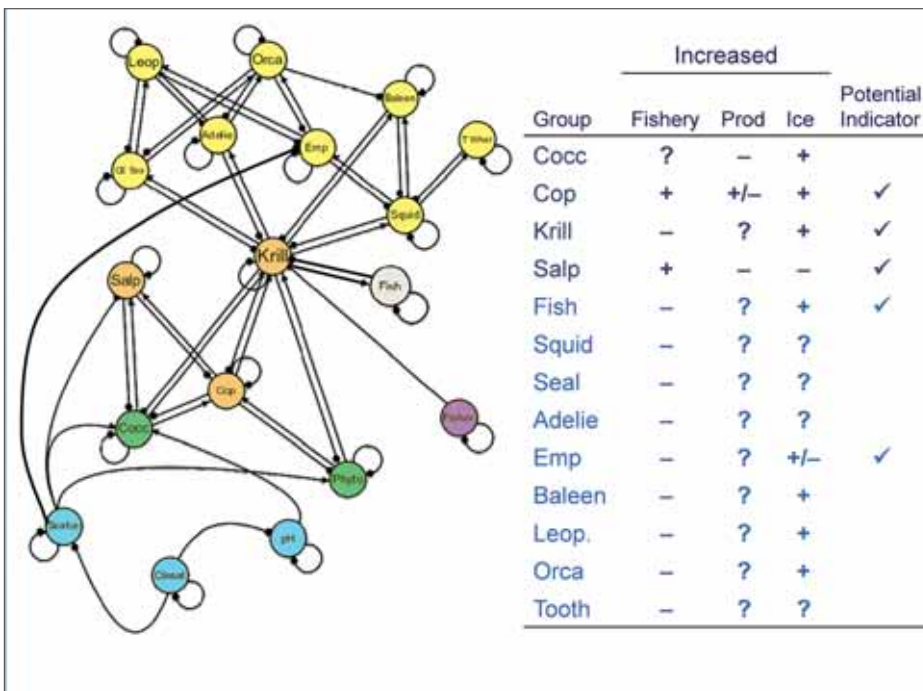

Figure 5.6. Qualitative model of a 'krill-based food web' (following de la Mare & Dambacher, unpublished). The network shows interactions amongst components of this illustrative ecosystem: sea ice, climate, pH = acidity, Cocc = Coccolithophorids, Phyto = Phytoplankton, Cop = Copepods, Salps, Krill, Fish, Squid, CE Seal = Crabeater seals, Adelie penguins, Emp = emperor penguins, Leop = Leopard seals, Orca, Baleen whales, T. Whal = toothed whales. The table shows the results of a qualitative assessment of the impacts of press perturbations on each group following the method of Dambacher *et al.* (2007, 2009)^{7, 8}. Rows correspond to each group from the network plus the responses from individual press perturbations from an increased krill fishery, increased productivity (Prod) and an increase in sea ice. '-' indicates a decline in the group while '+' indicates an increase. '?' indicates a confounded response. Potential indicators are checked on the basis of a clear signal in both fishery and ice as well as a capability to monitor them.

6. Design and Implementation

Antarctic nations have undertaken and sustained large scale scientific endeavours for over 100 years. The International Geophysical Year in 1957-58 bound them into a collaborative and coordinated effort that remains to this day in the Antarctic Treaty System, an effort exemplified once more in the recent International Polar Year (IPY). Science in Antarctica and the Southern Ocean has played a significant role in resolving difficult and uncertain global issues. Many scientists involved in Southern Ocean research have turned their attention to how much the climate will change, how much Earth's systems will be impacted and how those impacts will affect ecosystems and people. There is an increasing urgency to establish baseline measurements of ecosystem structure and function against which change can be measured. Scientists involved in environmental impact assessments and natural resource management have experience and expertise that could help design programs to support assessments of change and for developing prognoses for ecosystems in the future. This section summarises the strategies that are currently available to monitor change and approaches that could be used in developing a long-term assessment strategy which could optimally facilitate early warning assessments of future climate change impacts on marine ecosystems.

Monitoring the physical environment in the region is well coordinated and advanced, most notably through the satellite, WOCE, and Argo programs¹⁸. In contrast, many biota and their dynamics are not easily observed and there is no agreed set of biological diagnostics that indicate the state of ecosystems. The challenge is to develop a biological field program that can be combined with quantitative methods to assess and predict climate change impacts on Southern Ocean ecosystems.

Section 5 outlined the general issues to be considered in designing such a program. The Workshop agreed that detecting change from amongst the variability in the ecosystems is essential. However, the time-series may need to be decades long before such changes may be discerned. Measuring a number of indicators across different scales and processes within the ecosystem, including in areas with contrasting physical conditions, will assist this assessment and likely shorten the period in which change would be detected.

The expectation of significant change within the next two to three decades requires measurements of biota to begin before gaps in knowledge of ecosystem structure and function can be filled and a long-term strategy for gathering the data needed in impact assessments can be fully developed. How can such a field program evolve as knowledge is acquired without compromising the long term attributes of the datasets and the ability to assess climate change impacts in the future, particularly if the initial indicators need to be changed?

6.1. Currently Available Strategies To Monitor Change

The Workshop noted that, in the first instance, monitoring should comprise a suite of indicator species found across a range of trophic levels and habitats in order to encompass the different spatial and temporal scales of interactions in the ecosystem. These species should also, ideally, have the following attributes:

- sensitivity to variables expected to change under future climate change scenarios (observed previously in response to past change or through experimental work);
- recognised vulnerability to direct or indirect climate change impacts; and
- easy to measure on a large scale at low cost.

The Workshop agreed that, where possible, the monitoring should

- be linked to existing long-term monitoring programmes and relevant international initiatives, which will facilitate additional long-term continuity of datasets in assessments and potential for integrating with existing field programs;
- incorporate existing ecological hotspots, and identify and adapt to new ones; and
- be maintained in undisturbed areas.

Data derived from these activities could contribute to the development of ecosystem models and initial assessments of change in the interim of long-term requirements for the assessments being determined. The following discussion presents some of the methods available to be used at present and the programs that will be relevant to monitoring ecosystem dynamics.

Satellite remote sensing data is the most accessible synoptic data that is regularly available. Passive sensors include microwave, thermal infrared, near-infrared and visible spectra. Active sensors are RADAR and Laser. These satellites can, amongst others, measure sea surface height (locations of fronts and eddies), sea ice attributes (concentration and extent), sea surface temperature and ocean colour (concentrations of the primary phytoplankton pigment, Chlorophyll *a* [Chl *a*]), all of which are important factors influencing Southern Ocean ecosystems. The quality of these data has evolved since the early satellites of the 1970s. Estimates of chlorophyll *a* from ocean colour data are only available from 1979. The biggest challenge for using these data is the maintenance of high quality internally consistent datasets, which requires inter-calibration between sensors (satellites) as well as validating the values

for the variables derived from the data. Ship-based observations are needed to validate chlorophyll and sea ice measurements from satellites (Figure 6.2).

Chlorophyll data have great value in estimating spatial and temporal variability in standing crop of phytoplankton as well as primary production. With adequate knowledge of the food web dynamics, the consequences to higher trophic levels might be predicted. However, an accurate algorithm is needed to transform the estimate of surface density of Chl *a* to a biomass density of phytoplankton across its depth range. It requires knowledge of the concentrations of Chl *a* in different phytoplankton species, the species composition in the water column, and the depth in the water column to which this estimate of density can be applied, which is often assumed to be the whole mixed layer depth. This information has been difficult to acquire as it relies on ship-based observations but recent progress has been made in developing standard transformation procedures².

At-sea observations have in the past been undertaken from ships. In recent times, sensors have been deployed using autonomous ocean profiling floats (Argo), thousands of which are now observing the oceans. These floats transmit their observations of temperature and salinity when they surface at regular intervals. This enables the characteristics of the water masses to be monitored. These sensors are able to be deployed on moorings and autonomous underwater vehicles, as well as marine mammals that are being tracked using satellite telemetry to determine their foraging strategies (e.g. Figure 3.8). These sensors provide an opportunity to monitor the attributes of ocean habitats and how they change in space and time.

The tracking of marine mammals enables monitoring of the location and characteristics of their feeding habitats and how different species utilise those locations. Integrated studies of the distribution of predators and prey at these locations can then be used to determine the availability of prey to those predators (an important parameter in food web models) and whether those relationships may be changing.

Ship-based sampling is the most common form of measuring biota at sea. Methods include surface measurements using underway water samplers for phytoplankton and towed continuous plankton recorders (CPR) for zooplankton, and sampling at depth using

nets and acoustics (Figure 3.6), which can monitor mesopelagic species, including krill, zooplankton and fish. Each method has biases that need to be overcome. Many species, such as squid, can avoid capture in the nets, and not all species will reflect the sound waves used in acoustics. Acoustic technologies and analyses are improving, with the possibility of routine monitoring of the density of biota at depth because, unlike nets, acoustics can be implemented without having to alter a ship's activities¹³. Under these circumstances, monitoring for long-term change in the acoustic signal may be a useful indicator of ecosystem change with intensive efforts to identify species only when the signal changes substantially.

Systematic surveys provide the best method for estimating abundance (e.g. Figure 4.1)²⁰, particularly when integrating these estimates with other ecosystem processes¹⁷.

New technologies are emerging that could facilitate biological measurements, including the use of optical sensors on autonomous and remotely operated underwater vehicles, gliders and buoys. These will be very useful for measuring under-ice habitats in winter.

Land-based predators potentially integrate over large spatial scales and their population dynamics integrate over long temporal scales, which may have greater benefits in some cases than ship-based sampling. Tissue samples are now being used to estimate general dietary patterns over seasons using stable isotope analyses. For short term diet composition, faeces can be analysed using genetic analyses. These methods show much greater potential for understanding the relative abundances of prey and food web dynamics than the biased methods of the past based on gut samples.

Numerous intensive ecosystem studies have been undertaken since the Discovery expeditions beginning in 1925 and the advent of the Scientific Committee on Antarctic Research (SCAR – see appendix) through which the BIOMASS program was established in the 1970s¹⁰. Organisations and programs relevant to the work of ICED are listed in the appendix with summaries of some relevant national and international programs, including ICED, SOOS, SCAR, CCAMLR and SORP.

Ecosystem monitoring is an explicit part of the work of the Commission for the Conservation of Antarctic Marine Living Resources (CCAMLR – see appendix)^{1, 3, 14}. CCAMLR established its Ecosystem Monitoring Program (CEMP) in 1985 and developed three integrated study areas soon after – Antarctic

Peninsula¹¹, South Georgia (Isla Georgia del Sur) (see appendix)¹⁶ and Prydz Bay/Mawson Coast (see appendix). The data collected using standard methods are aimed at relating the performance of krill predators to the dynamics of krill and the environment.

Other long term integrated programs have been established at the Palmer LTER on the west Antarctic Peninsula⁹ and the Ross Sea (see appendix)¹⁹. Long-term land-based predator monitoring has been occurring at D'Umont Durville in eastern Antarctica and on Kerguelen Island²¹ and whales are regularly monitored through the International Whaling Commission's Southern Ocean Whale and Ecosystem Research program. More distant routine monitoring of predators is occurring through whale watching and the counting of migratory humpback whales, which is now part of the Southern Ocean Research Partnership (SORP – see appendix).

The candidate short-term monitoring strategies, which are being considered in the Southern Ocean Observing System¹⁸, a joint program of SCAR, SCOR, CLIVAR and CliC, would include further use of

- existing monitoring programs,
- satellite remote sensing with appropriate ship-based validation in the Southern Ocean,
- ships in the region (ships of opportunity) to routinely use devices such as continuous plankton recorders and, where possible, underway samplers,
- where possible, routine collection of acoustic data using ships in the region, and
- tracking of marine mammals for monitoring habitat characteristics with dataloggers.

Additional useful observations could include

- routine counts, where reliable, of marine mammals through voluntary operations, such as whale watching,
- samples of benthos in locations where they are expected to routinely integrate the water chemistry and productivity in the water column.

These programs may need to be adjusted to yield the data needed for signalling change in Southern Ocean ecosystems. Regular analyses will be needed to identify an optimal spatial configuration of sampling within the logistical constraints.



© Susan Doust

6.2. Developing A Long-Term Assessment Strategy

Assessments of current and future climate change impacts on Southern Ocean ecosystems will require^{8, 15}

- the development of models, based on plausible functional relationships between ecosystem components,
- estimates of parameters to be used in the models, and
- time-series of indicators prior to, during and after significant changes have occurred for fitting and validating the models.

Gaps in coverage of biological data from Southern Ocean ecosystems were evaluated by the Workshop. These are shown in Figure 6.3. Primarily, the broadest coverage to date has been on primary productivity of the region and krill. Micronutrients, microbes, benthos, mesopelagic fish and squid were identified as being poorly understood. Most time series on biota are short compared to the satellite series. Spatial coverage around Antarctica and knowledge of winter processes are both limited.

These gaps suggest that, in the first instance, the tools available for monitoring biota need to be applied in as many locations as possible, taking account of the known variation in habitats and ecosystems throughout the Southern Ocean.

Experience in the disciplines of environmental impact assessment and natural resource management can help identify and develop strategies for updating the field monitoring program as more data, knowledge and new efficient technologies are acquired. A key issue is how to achieve the objectives for the program, maintaining appropriate continuity and comparability amongst the data, and keeping within the limits of the resources available.

A tiered structure to field measurements may be an option, with the tools indicated above as the primary tier. As changes emerge or issues are identified then more detailed sampling may be used to estimate parameters, develop new functional relationships for the models or for obtaining more detailed diagnostics for those indicators exhibiting change. These campaigns would be akin to the integrated multidisciplinary science programs of SO-GLOBEC¹² and help provide the foundation for refining or choosing between the predictive models and guiding future monitoring.

In developing a long-term strategy, how can choices be made to deliver cost-effective improvements to the modelling and assessments? Box 6.1 discusses an approach presented to the Workshop for designing such strategies, which was initially developed in fisheries but has been generalised into a management-oriented paradigm (MOP) for environmental science to underpin decision-making⁶. It offers a useful approach for understanding the trade-offs between scope, accuracy, precision, cost and delivery speed among options for a long-term monitoring and assessment program to deliver its specified objectives. Given plausible future scenarios, this approach could be used to consider the spatial, temporal and biological coverage required at different times of the program and under which circumstances more intensive sampling would be undertaken.

Box 6.1. Approaches for Matching Objectives, Monitoring and Decision Making in the Face of Uncertainty

By Bill de la Mare, CSIRO, Cleveland, Australia

The success of a large scale research program is inherently uncertain; if we know how a program is going to turn out it is not research. A standard way of dealing with uncertainty is adaptive management. Designing an adaptive management system for a large-scale and expensive research program could be undertaken using a Management Oriented Paradigm (MOP) now used widely in fisheries management^{4,5,7}. A MOP consists of:

- Measurable management objectives;
- An explicit management process based on decision rules;
- Assessment methods, using specified data and methods; and
- Prospective evaluation using performance measures.

A MOP is deliberative, consultative, iterative and forward looking; the standard attributes of modern project planning. It can be used to understand the trade-offs between scope, accuracy, precision, cost and delivery speed among options for a long-term monitoring and assessment program to deliver specified objectives. It can be used as a generalised form of a power analysis to determine whether there is a high likelihood of accepting the best models from a field of candidates.

Prospective evaluation is the use of simulations to evaluate the likely performance of different monitoring and assessment programs. Adaptive management is essentially a negative feedback system as shown in Figure 6.1. To design that system, the real world, the research activities, the resulting data and model development are replaced by computer simulations.

Adaptive research management involves conducting research in a system where we measure and learn from the differences between objectives and outcomes. As a negative feedback system, research would be increased if an objective is not being met or cut back if it is being exceeded. An adaptive research management system would consist of

- Objectives, such as choosing from among a set of models the subset which is sufficiently consonant with the real world, according to some specified criteria and for a designated purpose,
- a set of potential indicators and data gathering activities that can be started, adjusted in intensity or stopped,
- a set of decision rules for making those adjustments

For the Southern Ocean Sentinel Program, one objective is to choose models that will be a suitable representation of the real world for making predictions with a specified reliability. The control action is the decisions about the next step in the research activities. Research activities are applied to the world to produce indicators and other data needed for the models. The data are then used in competing models (hypotheses) to corroborate or falsify them. Model attributes are compared with the

objectives of the research program. If the model attributes are consistent with our objectives the program is complete. If the model attributes do not meet the objectives then the research activity is modified by collecting more or different data, dropping or adding one or more models, identifying new research opportunities or methods or the objectives may need to be modified or even abandoned.

The adaptive decision making process is determined, as far as possible, in advance. A decision rule specifies the information to be used in making a decision, the criteria on which the decision is based, and the set of decisions (actions to apply) that can be made. The decisions in research management are to start, vary or remove research activities by comparing an assessment of success so far with program objectives. The rules must be complete, i.e. a decision is anticipated for all of the different possible relationships between the information and the criteria. A rule or its context must also specify who makes the decision and when.

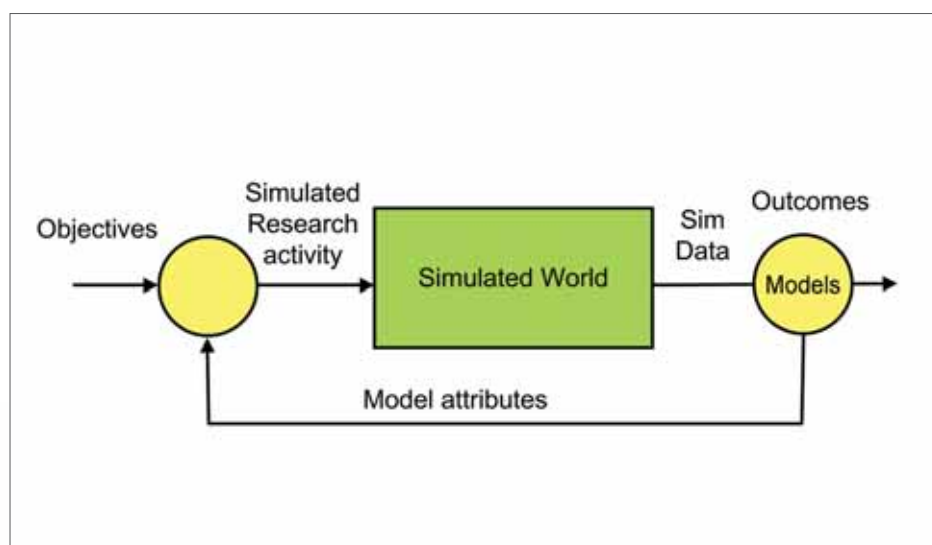

Figure 6.1. Schematic of a simulation for evaluating a monitoring and assessment strategy using the Management Oriented Paradigm.

6.4. Figures

Figure 6.2. The Sea Ice Physics and Ecosystem (SIPEX) program was a major Australian field campaign that contributed to the International Polar Year. The relationships between physical, biological and biogeochemical sea ice environments were investigated to understand the role of sea ice in Southern Ocean ecosystems. The bottom photo (Photo: T. Worby, AAD) shows a measurement transect at one ice station. Measurements included ice and snow thickness, ice structure and snow properties. These data were used to calibrate airborne laser and radar altimetry for determining ice and snow thickness remotely. Under-ice measurements of ice algal distribution were collected using a Remotely Operated Vehicle (top left - Photo: K. Meiners, ACE CRC). At nearby sites, complementary measurements were taken of nutrients, Chlorophyll *a*, particulate organic carbon, and iron concentration.

Top right (Photo: T. Worby, AAD): Regional scale mapping of sea ice thickness is a key to understanding changes in the sea ice environment, and for providing data to calibrate and validate satellite altimetry products that are being developed to provide global coverage. The Australian Antarctic Division developed an airborne system for measuring sea ice thickness over tens to hundreds of kilometres using a laser altimeter to measure the height of the ice or snow surface above sea level, which in conjunction with surface-based observations, can be used to calculate total sea ice thickness.



Figure 6.3. Indication by the Workshop of information currently available for different components of Southern Ocean ecosystems. Colours indicate whether a component is well described in relation to the topic: red = mostly undescribed, yellow = parts are well described, green = good descriptions. Topics: Types = understanding of groups within the components, e.g. physical processes/attributes, elements or species; Linkages = ecological linkages between the subject component and other components; Functional = quantitative understanding of the functional relationships between components; Spatial = understanding of spatial variability in components; Temporal = understanding of temporal variability in components; Data time series = regular collection of data on the component over time to observe their dynamics.

	Physics	Macronutrients	Micronutrients	Microbes and Phytoplankton	Krill	Gelatinous Zoopl.	Other zoopl.	Cephalopods	Fish	Air breathing	Benthos	People
Types (taxonomy)	Yellow	Green	Red	Red	Green	Red	Green	Yellow	Green	Yellow	Red	Yellow
Linkages	Green	Green	Red	Red	Green	Red	Green	Red	Red	Yellow	Red	Yellow
Functional	Green	Green	Red	Red	Yellow	Yellow	Red	Red	Red	Yellow	Yellow	Yellow
Spatial	Yellow	Yellow	Red	Yellow	Yellow	Yellow	Yellow	Red	Red	Yellow	Red	Yellow
Temporal	Yellow	Yellow	Red	Yellow	Yellow	Red	Red	Red	Red	Yellow	Red	Yellow
Data time series	Green	Yellow	Red	Yellow	Green	Green	Green	Yellow	Yellow	Yellow	Yellow	Yellow

7. Establishing A Southern Ocean Sentinel

Regional and global policy imperatives need assessments of current and future climate change impacts on Southern Ocean marine ecosystems. A Southern Ocean Sentinel can fill this role. Two important research programs, the Integrating Climate and Ecosystem Dynamics in the Southern Ocean (ICED) of IMBER and the SCAR/SCOR / CLIVAR / CliC's Southern Ocean Observing System (SOOS) are developing, respectively, understanding of climate change impacts on Southern Ocean ecosystems, which will include the development of 'end-to-end' models, and a framework for obtaining the measurements needed to improve our understanding of change in the Southern Ocean. A Southern Ocean Sentinel addresses key objectives of the ICED program and could, therefore, be most appropriately developed as part of ICED becoming one of its legacy outcomes. It will also provide the basis for developing key links between ICED and the SOOS program, along with linking other programs and organisations to information on how climate change impacts their activities, such as the Commission for the Conservation of Antarctic Marine Living Resources (CCAMLR) and the Antarctic Treaty Consultative Meeting (ATCM). This section summarises the conclusions of the Workshop, including the important international climate change questions to which a Southern Ocean Sentinel will contribute and an initial work plan from the Workshop for contributing early warning assessments of climate change impacts on marine ecosystems.

CCAMLR and ATCM have agreed that climate change could impact on their activities and ability to meet their objectives^{2,3}. In 2009, a joint meeting of the Scientific Committee of CCAMLR and the ATCM Committee on Environmental Protection recommended that the establishment or further development of complementary baselines, reference areas, and appropriate indicators was needed⁴.

The Intergovernmental Panel on Climate Change (IPCC), in its fourth review, highlighted a number of uncertainties to be resolved in relation to climate change impacts on polar environments in order to better assess future impacts in the Southern Ocean and elsewhere¹. These uncertainties along with the IPCC recommendations on how to resolve them are provided in Table 7.01. The Workshop further discussed some key questions for improving capabilities and necessary infrastructure to assess climate change impacts on Southern Ocean ecosystems. These questions are detailed in Table 7.2, along with suggested short-term activities that will provide guidance in assessments prior to the completion of more detailed studies.

The Workshop agreed that, while our ability to make future predictions of ecosystem changes are hampered by uncertainties, sufficient information is now available to identify many aspects of Southern Ocean ecosystems that are at present or could be in the future impacted by changes in the physical systems. Tools are also now available to integrate disparate data sources to help give coherent assessments of imminent and future change in Southern Ocean ecosystems.

The Workshop agreed that these existing tools, combined with long-term measurements of key indicators, should be used to develop assessment and predictive models in order to provide two assessments for use by governments, IPCC and other international forums:

- current climate change impacts on Southern Ocean ecosystems to inform governments of the consequences of climate change on populations, species and ecosystems; and
- predicted future impacts on marine ecosystems, using select indicators of Southern Ocean ecosystems as early warning signals, to inform managers of human activities and ecosystem services that could be impacted by climate change.

A Southern Ocean Sentinel will fill this role.

These two types of assessments require the support of a long-term systematic program to differentiate between plausible explanations for change in Southern Ocean ecosystems, as well as estimating the changes themselves. Such a program will need to address regional ecosystem variation to ensure that biases are not inherent in measurements and models. At present, the patchy nature (in terms of spatial, temporal and species coverage) of long-term programs means that some changes may be occurring without detection.

The Workshop noted that this work will necessarily require:

- long-term multi-decadal measurements of key indicators, and
- shorter-term, multi-year studies to estimate model parameters and test the plausibility of different models, including comparative studies across regions and, possibly, between the polar seas.

Systematic measurements of change will need to start soon if climate change impacts are to be properly assessed. Strategies and procedures that distinguish the effects of climate change from other human activities, such as fishing, are also required.

7.1. A Southern Ocean Sentinel

The policy and scientific imperatives described above have stimulated the development of two international collaborative programs which are important for investigating climate change impacts on Southern Ocean ecosystems.

- the ICED program⁵, which is aimed at developing understanding of climate change impacts on Southern Ocean ecosystems, including the development of models to assist in this task, such as ‘end-to-end’ models, and
- the SOOS program, which is an international collaborative monitoring program for the Southern Ocean under the auspices of SCAR, SCOR, CLIVAR and CliC⁶.

A Southern Ocean Sentinel addresses key objectives of the ICED programme. It will also provide the basis for developing key links between ICED and the SOOS programme, along with linking other programs and organisations to information on how climate change impacts on their activities, such as CCAMLR and the ATCM.

The Workshop agreed that developing and implementing a Southern Ocean Sentinel is, by necessity, an international effort because

- the problem is globally significant, the outcomes are globally useful and the region is governed by international forums, and
- change needs to be measured across the Southern Ocean, particularly in different areas with different prognoses for change, and over at least 50 years, which will involve many nations and scientists and requiring a long-term commitment to sustained resources.

A preliminary definition of the scope of a Southern Ocean Sentinel was developed by the Workshop for consideration by ICED. This is provided in Table 7.3.

7.2. Next Steps

The Workshop agreed that Southern Ocean Sentinel would be most appropriately developed and coordinated as part of ICED, becoming one of its legacy outcomes. The Workshop agreed that ICED be approached to include the Southern Ocean Sentinel as part of its scientific program. Southern Ocean Sentinel could then be developed as part of the wider community effort to understand the impacts of climate change in Southern Ocean ecosystems. It also suggested that the Southern Ocean Sentinel could be a mechanism for further developing the biological component of monitoring in SOOS and that this should be developed through ICED.

The Workshop agreed that a necessary first step would be delivery of qualitative and preliminary quantitative assessments of climate change impacts on the Southern Ocean to be ready in time for use by the IPCC in its fifth review of climate change. It was suggested that such assessments be undertaken at least for different regions of the Southern Ocean to take account of the regional differences in ecosystem characteristics and climate change impacts.

In conclusion, the wide-ranging and detailed discussions of the Workshop highlighted the existing capacity to undertake assessments of climate change impacts on Southern Ocean marine ecosystems. The Workshop agreed there is an urgent need for developing a long-term monitoring and assessment capability for Southern Ocean ecosystems as a whole. A Southern Ocean Sentinel could be developed as an integrative concept aimed at detecting and assessing early warning signals of climate change impacts on marine ecosystems. The Workshop agreed that this needs to be closely coordinated as part of current and planned Southern Ocean initiatives and that this would most appropriately be achieved by Southern Ocean Sentinel being developed as part of ICED.

7.3. Tables

Table 7.1. IPCC key uncertainties and related scientific recommendations/approaches for Polar regions (Source: Table 15.1, Anisimov *et al.* 2007)¹.

IPCC key Uncertainty	Recommendation and Approach
Detection and projection of changes in terrestrial, freshwater and marine Arctic and Antarctic biodiversity and implications for resource use and climatic feedbacks	Further development of integrated monitoring networks and manipulation experiments; improved collation of long-term data sets; increased use of traditional knowledge and development of appropriate models
Current and future regional carbon balances over Arctic landscapes and polar oceans, and their potential to drive global climate change	Expansion of observational and monitoring networks and modelling strategies
Impacts of multiple drivers (e.g., increasing human activities and ocean acidity) to modify or even magnify the effects of climate change at both poles	Development of integrated bio-geophysical and socio-economic studies
Fine-scaled spatial and temporal variability of climate change and its impacts in regions of the Arctic and Antarctic	Improved downscaling of climate predictions, and increased effort to identify and focus on impact 'hotspots'
The combined role of Arctic freshwater discharge, formation/melt of sea ice and melt of glaciers/ice sheets in the Arctic and Antarctic on global marine processes including the thermohaline circulation	Integration of hydrologic and cryospheric monitoring and research activities focusing on freshwater production and responses of marine systems
The consequences of diversity and complexity in Arctic human health, socio-economic, cultural and political conditions; interactions between scales in these systems and the implications for adaptive capacity	Development of standardised baseline human system data for circumpolar regions; integrated multidisciplinary studies; conduct of sector-specific, regionally specific human vulnerability studies
Model projections of Antarctic and Arctic systems that include thresholds, extreme events, step-changes and non-linear interactions, particularly those associated with phase-changes produced by shrinking cryospheric components and those associated with disturbance to ecosystems	Appropriate interrogation of existing long-term data sets to focus on non-linearities; development of models that span scientific disciplines and reliably predict non-linearities and feedback processes
The adaptive capacity of natural and human systems to cope with critical rates of change and thresholds/tipping points	Integration of existing human and biological climate-impact studies to identify and model biological adaptive capacities and formulate human adaptation strategies

Table 7.2. Four central questions and the initial research approaches identified by the Workshop that will be important to address in order to facilitate IPCC assessments of climate change impacts on Southern Ocean ecosystems.

Question	Initial approaches
1. What are the key relationships between biological processes and environmental variables, particularly in relation to consequences on marine mammals and birds?	Literature meta-analysis of energetic and demographic relationships between species and their physical environment.
2. How does sea ice biology respond to environmental change, especially a. in winter? b. Horizontal distribution of sea ice primary production	Implement sea ice physical/biological models at large scales Parameterise sea ice biological processes so that they can be included in IPCC models
3. Can phytoplankton species composition changes during climate shifts be represented within ecosystem models?	Literature meta-analysis of physiological relationships of algae with light, nutrients and temperature Improved model parameterisations of phytoplankton physiology
4. Can storm or other extreme events be included in IPCC-type models in order to represent key physical processes of importance to biota, such as mixing of the water column and land-based weather exposure in vertebrates?	Estimate statistical descriptions of storm events at a scale relevant to biota Develop approaches to parameterising storm impacts on biological processes

Table 7.3. A preliminary definition of the scope of a Southern Ocean Sentinel.

Mission
The Southern Ocean Sentinel will be an international multidisciplinary scientific effort to provide early warning of climate change impacts on global marine and other ecosystems based on Southern Ocean ecosystem indicators and assessments of climate change impacts in the region.
Vision
To see with clarity and consensus, the consequences of future climate for Southern Ocean marine ecosystems.
Objectives
The Southern Ocean Sentinel will provide information on the impacts of climate change in the Southern Ocean and will:
<ul style="list-style-type: none"> • establish and utilise methods, including models, for predicting imminent and future change in Southern Ocean ecosystems, locally, regionally and synoptically; • develop methods and use Southern Ocean ecosystem indicators as early-warning signals for triggering advance planning and response actions in other global regions; • develop an active, adaptive long-term field program to measure early warning indicators and associated parameters for use in the predictive models; and • present outcomes (e.g. system assessments), and synthesise, review and regularly update predictions.

8. Post Script

Many people at the workshop noted the great potential for achieving a high level of evidence of climate change impacts on Southern Ocean marine ecosystems by having integrated programs in the west Antarctic Peninsula, southwest Atlantic, eastern Antarctica and the Ross Sea. This is because of the differences in expected climate change impacts on the physical attributes of the regions and the different environments in which similar species have to live. Given the contents of this report, it would seem that a long-term program across these regions would be useful for estimating change and identifying the species-specific responses that might arise. These could then be used in the elaboration of models to predict future climate change impacts on marine ecosystems. This spatial structure, which was evident in these discussions, is illustrated in the figure attached to this post-script.

We are indebted to all who participated in this workshop for sharing their time, wisdom and assistance in collating the information as well as formulating the ideas and approaches presented in this report. We also appreciated greatly the assistance provided by many in the production of the report. Thank you.

A Southern Ocean Sentinel will be a natural component of ICED, as well as providing the basis for developing key links between ICED and the SOOS programme. Within these programs, we look forward to developing a Southern Ocean Sentinel in close coordination and collaboration with the wider Southern Ocean scientific community.

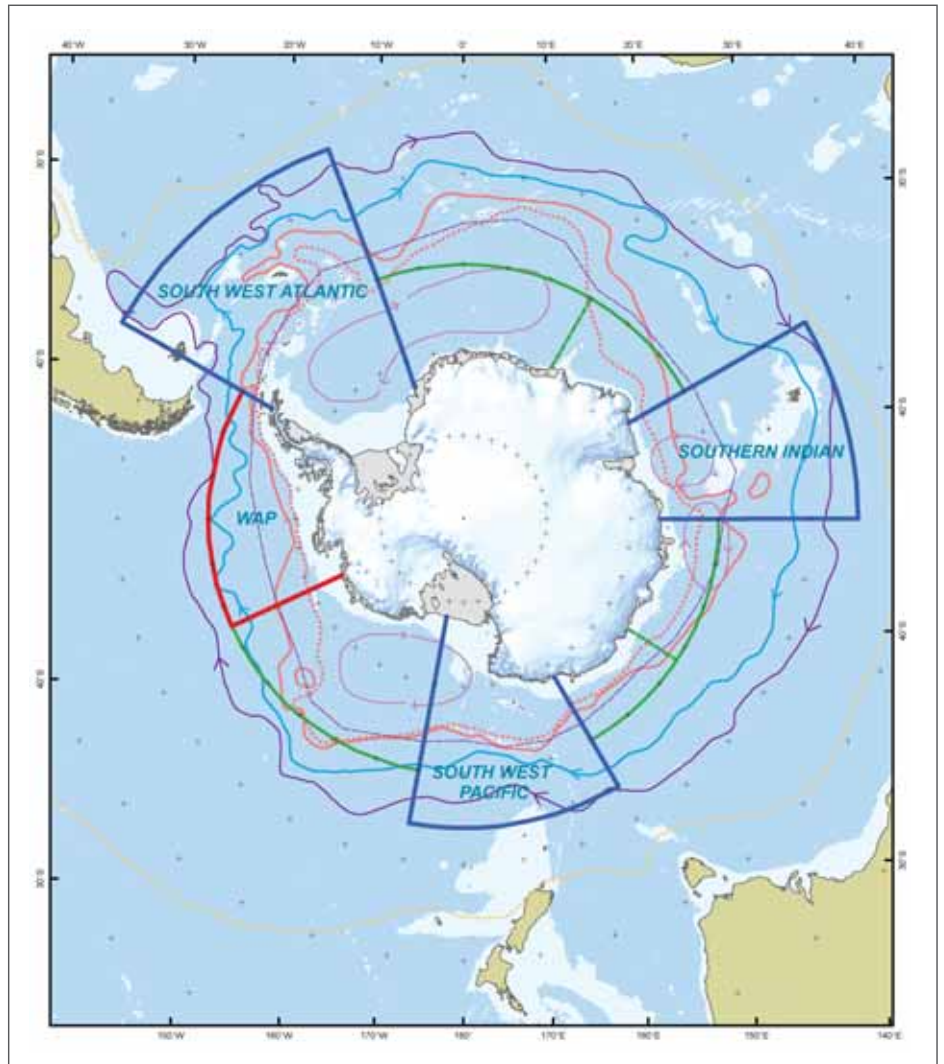

Figure: Possible spatial configuration of a Southern Ocean Sentinel with four main areas – West Antarctic Peninsula, South-West Atlantic, Southern Indian and South West Pacific. Those areas outlined in green indicate coastal areas that could be used to help differentiate between hypotheses of change in the high latitude areas.

References

1. Introduction

- 1 CCAMLR. 2008. *Report of the twenty seventh meeting of the Commission for the Conservation of Antarctic Marine Living Resources*. CCAMLR, Hobart. 203 pp.
- 2 CCAMLR. 2009. *Statistical Bulletin (1999-2008)*. CCAMLR, Hobart. 241 pp.
- 3 Clarke A, Murphy EJ, Meredith MP, King JC, Peck LS, Barnes DKA, Smith RC. 2007. Climate change and the marine ecosystem of the western Antarctic Peninsula. *Philosophical Transactions of the Royal Society B-Biological Sciences* **362**: 149-166.
- 4 FAO. 2005. *Review of the state of world marine fishery resources*, FAO Fisheries Technical Paper. No. 457. FAO, Rome. 235 pp.
- 5 Gitay H, Suarez A, Dokken DJ, Watson RT. 2002. Climate change and biodiversity. *IPCC Technical Paper V. Intergovernmental Panel on Climate Change*
- 6 Harley CDG, Hughes AR, Hultgren KM, Miner BG, Sorte CJB, Thornber CS, Rodriguez LF, Tomanek L, Williams SL. 2006. The impacts of climate change in coastal marine systems *Ecology Letters* **9**: 228-241.
- 7 Hegerl GC, Bindoff NL. 2005. Ocean science - Warming the world's oceans. *Science* **309**: 254-255.
- 8 Hegerl GC, Karl TR, Allen M, Bindoff NL, Gillett N, Karoly D, Zhang XB, Zwiers F. 2006. Climate change detection and attribution: Beyond mean temperature signals. *Journal of Climate* **19**: 5058-5077.
- 9 Hitz S, Smith J. 2004. Estimating global impacts from climate change. *Global Environmental Change-Human and Policy Dimensions* **14**: 201-218.
- 10 IPCC. 2001. *Climate Change 2001: The Scientific Basis. Contribution of Working Group I to the Third Assessment Report of the Intergovernmental Panel on Climate Change*. Cambridge University Press, Cambridge, United Kingdom and New York, NY, USA
- 11 IPCC. 2007. *Climate Change 2007: The physical basis. Contribution of Working Group I to the Fourth Assessment Report of the Intergovernmental Panel on Climate Change*. Cambridge University Press, Cambridge, UK & NY. 996 pp.
- 12 Lange MA, Blindow N, Breuer B, Grosfeld K, Kleiner T, Mohrholz CO, Nicolaus M, Oelke C, Sandhager H, Thoma M. 2005. Numerical model studies of Antarctic ice-sheet-ice-shelf-ocean systems and ice caps. *Annals of Glaciology, Vol 41, 2005* **41**: 111-120.
- 13 Learmonth JA, MacLeod CD, Santos MB, Pierce GJ, Crick HQP, Robinson RA. 2006. Potential effects of climate change on marine mammals. *Oceanography and Marine Biology - an Annual Review, Vol 44* **44**: 431-464.
- 14 Mayewski PA, Maasch KA, Yan YP, Kang SC, Meyerson EA, Sneed SB, Kaspari SD, Dixon DA, Osterberg EC, Morgan VI, Van Ommen T, Curran MAJ. 2005. Solar forcing of the polar atmosphere. *Annals of Glaciology, Vol 41, 2005* **41**: 147-154.
- 15 Mayewski PA, Meredith MP, Summerhayes CP, Turner J, Worby A, Barrett PJ, Casassa G, Bertler NAN, Bracegirdle T, Garabato ACN, Bromwich D, Campbell H, Hamilton GS, Lyons WB, Maasch KA, Aoki S, Xiao C, van Ommen T. 2009. State of the Antarctic and Southern Ocean Climate System. *Reviews of Geophysics* **47**
- 16 McNeil BI, Tilbrook B, Matear RJ. 2001. Accumulation and uptake of anthropogenic CO₂ in the Southern Ocean, south of Australia between 1968 and 1996. *Journal of Geophysical Research-Oceans* **106**: 31431-31445.
- 17 Meehl GA, Stocker TF, Collins WD, Friedlingstein P, Gaye AT, Gregory JM, Kitoh A, Knutti R, Murphy JM, Noda A, Raper SCB, Watterson IG, Weaver AJ, Zhao Z-C. 2007. Global Climate Projections. In, S Solomon, D Qin, M Manning, Z Chen, M Marquis, et al eds.), *Climate Change 2007: The Physical Science Basis. Contribution of Working Group I to the Fourth Assessment Report of the Intergovernmental Panel on Climate Change*. Cambridge University Press, Cambridge, UK & New York, USA.
- 18 Meredith MP, King JC. 2005. Rapid climate change in the ocean west of the Antarctic Peninsula during the second half of the 20th century. *Geophysical Research Letters* **32**
- 19 Moline MA, Claustre H, Frazer TK, Schofield O, Vernet M. 2004. Alteration of the food web along the Antarctic Peninsula in response to a regional warming trend. *Global Change Biology* **10**: 1973-1980.
- 20 Rosenzweig C, Casassa G, Karoly DJ, Imeson A, Liu C, Menzel A, Rawlins S, Root TL, Seguin B, Tryjanowski P. 2007. Assessment of observed changes and responses in natural and managed systems. In, ML Parry, OF Canziani, JP Palutikof, P Jvd Linden, CE Hanson eds.), *Climate Change 2007: Impacts, Adaptation and Vulnerability. Contribution of Working Group II to the Fourth Assessment Report of the Intergovernmental Panel on Climate Change*. Cambridge University Press, Cambridge, UK, pp. 79-131.
- 21 Sarmiento JL, Slater R, Barber R, Bopp L, Doney SC, Hirst AC, Kleypas J, Matear R, Mikolajewicz U, Monfray P, Soldatov V, Spall SA, Stouffer R. 2004. Response of ocean ecosystems to climate warming. *Global Biogeochemical Cycles* **18**
- 22 Seidov D, Barron E, Haupt BJ. 2001. Meltwater and the global ocean conveyor: northern versus southern connections. *Global and Planetary Change* **30**: 257-270.
- 23 Siedler G, Church J, Gould J. 2001. *Ocean circulation and climate: observing and modelling the global ocean*. Academic Press, London, UK. 717 pp.
- 24 Sreenivasan G, Majumdar TJ. 2006. Mapping of Antarctic sea ice in the depletion phase: an indicator of climatic change? *Current Science* **90**: 851-857.
- 25 Walther GR, Post E, Convey P, Menzel A, Parmesan C, Beebee TJC, Fromentin JM, Hoegh-Guldberg O, Bairlein F. 2002. Ecological responses to recent climate change. *Nature* **416**: 389-395.

2. The Southern Ocean

- 1 Adams N. in press. Advances in numerical modelling of the weather in Antarctica and the surrounding Southern Ocean. *Australian Meteorological and oceanographic journal*

- 1a Arrigo KR., van Dijken GL. 2003. Phytoplankton dynamics within 37 Antarctic coastal polynyas. *Journal of Geophysical Research* **108**(C8), 3271, 10.1029/2002JC001739

- 2 Beaman RJ, Harris PT. 2005. Bioregionalization of the George V Shelf, East Antarctica. *Continental Shelf Research* **25**: 1657-1691.

- 3 Bindoff NL, Rosenberg MA, Warner MJ. 2000. On the circulation and water masses over the Antarctic continental slope and rise between 80 and 150°E. *Deep-Sea Research II* **47**: 2299-2326.

- 4 Chisholm SW. 2000. Oceanography - Stirring times in the Southern Ocean. *Nature* **407**: 685-687.

- 5 Clarke A. 1988. Seasonality in the Antarctic marine environment. *Comparative Biochemistry & Physiology* **90B**: 461-473.

- 6 Comiso JC. 1995. *SSM/I concentrations using the Bootstrap algorithm*. NASA Reference Publication 1380. NASA, Washington D.C., USA. 40pp.

- 7 Constable AJ, Nicol S, Strutton PG. 2003. Southern Ocean productivity in relation to spatial and temporal variation in the physical environment. *Journal of Geophysical Research* **108**: 1-10.

- 8 Fowler C. 2003. Updated 2007 Polar Pathfinder Daily 25km EASE-Grid Sea Ice Motion Vectors. Digital media. Boulder, Colorado, USA: National Snow and Ice Data Centre

- 9 Guinotte JM, Orr J, Cairns S, Freiwald A, Morgan L, George R. 2006. Will human-induced changes in seawater chemistry alter the distribution of deep-sea scleractinian corals? *Frontiers in Ecology and the Environment* **4**: 141-146.

- 10 Holm-Hansen O, Naganobu M, Kawaguchi S, Kameda T, Krasovski I, Tchernyshkov P, Priddle J, Korb R, Brandon M, Demer D, Hewitt RP, Kahru M, Hewes CD. 2004. Factors influencing the distribution, biomass, and productivity of phytoplankton in the Scotia Sea and adjoining waters. *Deep Sea Research Part II* **51**: 1333-1350.

- 11 Hughes CW, Woodworth PL, Meredith MP, Stepanov V, III TW, Pyne A. 2003. Coherence of Antarctic sea levels, southern hemisphere annular mode, and flow through Drake Passage. *Geophysical Research Letters* **30**: (doi:10.1029/2003GL017240).

- 12 Lannuzel D, Schoemann V, Pasquer B, Merwe Pvd, Bowie AR. 2009. What controls the distribution of dissolved iron in Antarctic sea ice? Spatial, seasonal and inter-annual variability. *Journal of Geophysical Research - Biogeosciences* **accepted**

- 13 Longhurst AR. 2007. *Ecological geography of the sea*. Academic Press, London, UK. 542 pp.

- 14 Lumpkin R, Speer K. 2007. Global ocean meridional overturning. *Journal of Physical Oceanography* **37**: 2550-2562.

- 15 Martin JH. 1992. Iron as a limiting factor in oceanic productivity. In, PG Falkowski, AD Woodhead eds.), *Primary productivity and biogeochemical cycles in the sea*. Plenum Press, New York, NY, pp. 123-138.

- 16 Massom RA, Hill KL, Lytle VI, Worby AP, Paget M, Allison I. 2001. Effects of regional fast-ice and iceberg distributions on the behaviour of the Mertz Glacier polynya, East Antarctica. In, MO Jeffries, H Eicken eds.), *Annals of Glaciology*, Vol 33, pp. 391-398.

- 17 Meehl GA, Stocker TF, Collins WD, Friedlingstein P, Gaye AT, Gregory JM, Kitoh A, Knutti R, Murphy JM, Noda A, Raper SCB, Watterson IG, Weaver AJ, Zhao Z-C. 2007. Global Climate Projections. In, S Solomon, D Qin, M Manning, Z Chen, M Marquis, et al eds.), *Climate Change 2007: The Physical Science Basis. Contribution of Working Group I to the Fourth Assessment Report of the Intergovernmental Panel on Climate Change*. Cambridge University Press, Cambridge, UK & New York, USA.

- 18 Meredith MP, Woodworth PL, Hughes CW, Stepanov V. 2004. Changes in the ocean transport through Drake Passage during the 1980s and 1990s, forced by changes in the Southern Annular Mode. *Geophysical Research Letters* **31**: L21305 (doi:21310.21029/22004GL021169).

- 19 Murphy EJ, Watkins JL, Trathan PN, Reid K, Meredith MP, Thorpe SE, Johnston NM, Clarke A, Tarling GA, Collins MA, Forcada J, Shreeve RS, Atkinson A, Korb R, Whitehouse MJ, Ward P, Rodhouse PG, Enderlein P, Hirst AG, Martin AR, Hill SL, Staniland IJ, Pond DW, Briggs DR, Cunningham NJ, Fleming AH. 2007. Spatial and temporal operation of the Scotia Sea ecosystem: a review of large-scale links in a krill centred food web. *Philosophical Transactions of the Royal Society B-Biological Sciences* **362**: 113-148.

- 20 Nicol S. 2006. Krill, currents, and sea ice: *Euphausia superba* and its changing environment. *BioScience* **56**: 111-120.

- 21 Nicol S, Allison I. 1997. The frozen skin of the Southern Ocean. *American Scientist* **85**: 426-439.

- 22 Orsi AH, Whitworth III T, Nowlin Jr WD. 1995. On the meridional extent and fronts of the Antarctic Circumpolar Current. *Deep-Sea Research* **42**: 641-673.

- 23 Rintoul SR. 2000. Southern ocean currents and climate. *Papers and Proceedings of the Royal Society of Tasmania* **133**: 41-50.

- 24 Rintoul SR, Hughes CW, Olbers D. 2001. The Antarctic Circumpolar Current System. In, G Siedler, J Church, J Gould eds.), *Ocean circulation and climate: observing and modelling the global ocean*. Academic Press, pp. 271-302.

- 25 Sokolov S, Rintoul SR. 2007. On the relationship between fronts of the Antarctic Circumpolar Current and surface chlorophyll concentrations in the Southern Ocean. *Journal of Geophysical Research-Oceans* **112**

- 26 Sokolov S, Rintoul SR, Wienecke B. 2006. Tracking the Polar Front south of New Zealand using penguin dive data. *Deep-Sea Research Part I-Oceanographic Research Papers* **53**: 591-607.

- 27 Thomas DN, Dieckmann GS eds.) 2003. *Sea Ice: An Introduction to Its Physics, Chemistry, Biology and Geology* Blackwell, Oxford UK. 402 pp.

- 28 Williams GD, Bindoff NL, Marsland SJ, Rintoul SR. 2008. Formation and export of dense shelf water from the Adélie Depression, East Antarctica. *Journal of Geophysical Research* **113**: (doi:10.1029/2007JC004346).

3. Biota Of The Southern Ocean

- 1 Andrewartha HG, Birch LC. 1984. *The Ecological Web: More on the Distribution and Abundance of Animals*. University of Chicago Press, Chicago
- 2 Atkinson A, Siegel V, E.A. P, Rothery P, Loeb V, Ross RM, Quetin LB, Schmidt K, Fretwell P, Murphy EJ, Tarling GA, Fleming AH. 2008. Oceanic circumpolar habitats of Antarctic krill. *Marine Ecology Progress Series* **362**: 1-23.
- 3 Atkinson A, Ward P, Hunt B, Pakhomov E, Hosie G. in prep. Zooplankton in Southern Ocean food web models: a critique of available data. *in prep*
- 4 Barnes DKA, Conlan KE. 2007. Disturbance, colonization and development of Antarctic benthic communities. *Philosophical Transactions of the Royal Society B* **2007**: 11-38.
- 5 Beaman RJ, Harris PT. 2005. Bioregionalization of the George V Shelf, East Antarctica. *Continental Shelf Research* **25**: 1657-1691.
- 6 Biuw M, Boehme L, Guinet C, Hindell M, Costa D, Charrassin J-B, Roquet F, Bailleul F, Meredith M, Thorpe S, Tremblay Y, McDonald B, Park YH, Rintoul SR, Bindoff N, Goebel M, Crocker D, Lovell P, Nicholson J, Monks F, Fedak MA. 2007. Variations in behavior and condition of a Southern Ocean top predator in relation to in situ oceanographic conditions. *Proceedings of the National Academy of Sciences of the United States of America* **104**: 13705-13710.
- 7 Bost CA, Zorn T, Maho YL, Duhamel G. 2002. Feeding of diving predators and diel vertical migration of prey: King Penguins' diet versus trawl sampling at Kerguelen Islands. *Marine Ecology Progress Series* **227**: 51-61.
- 8 Boyd PW. 2002. Environmental factors controlling phytoplankton processes in the Southern Ocean. *Journal of Phycology* **38**: 844-861.
- 9 Brandt A, Broyer Cd, Mesel Id, Ellingsen KE, Gooday AJ, Hilbig B, Linse K, Thomson MRA, Tyler PA. 2007. The biodiversity of the deep Southern Ocean benthos. *Philosophical Transactions of the Royal Society B* **362**: 39-66.
- 10 Brandt A, Gooday AJ, Brandao SN, Brix S, Brokeland W, Cedhagen T, Choudhury M, Cornelius N, Danis B, De Mesel I, Diaz RJ, Gillan DC, Ebbe B, Howe JA, Janussen D, Kaiser S, Linse K, Malyutina M, Pawlowski J, Raupach M, Vanreusel A. 2007. First insights into the biodiversity and biogeography of the Southern Ocean deep sea. *Nature* **447**: 307-311.
- 11 Casey KS, Comillon P. 1999. A comparison of satellite and in situ based sea surface temperature climatologies. *Journal of Climate* **12**: 1848-1863.
- 12 Clarke A, Johnstone NM. 2003. Antarctic marine benthic diversity. *Oceanography and Marine Biology: an annual review* **41**: 47-114.
- 13 Collins MA, Rodhouse PGK. 2006. Southern Ocean cephalopods. *Advances in Marine Biology* **50**: 191-265.
- 14 Collins MA, Xavier JC, Johnston NM, North AW, Enderlein P, Tarling GA, Waluda CM, Hawker EJ, Cunningham NJ. 2008. Patterns in the distribution of myctophid fish in the northern Scotia Sea ecosystem. *Polar Biology* **31**: 837-851.
- 15 Comiso J. 1999. *Bootstrap sea ice concentrations for NIMBUS-7 SMMR and DMSP SSM/I. (updated 2005)*. National Snow and Ice Data Center, Boulder, CO, USA. pp.
- 16 Constable AJ. 2005. A possible framework in which to consider plausible models of the Antarctic marine ecosystem for evaluating krill management procedures. *CCAMLR Science* **12**: 99-117.
- 17 Constable AJ, Nicol S, Stratton PG. 2003. Southern Ocean productivity in relation to spatial and temporal variation in the physical environment. *Journal of Geophysical Research* **108**: 1-10.
- 18 Costa DP, Klinck JM, Hofmann EE, Dinniman MS, Burns JM. 2008. Upper ocean variability in west Antarctic Peninsula continental shelf waters as measured using instrumented seals. *Deep-Sea Research Part II-Topical Studies in Oceanography* **55**: 323-337.
- 19 Croxall JP, Trathan PN, Murphy EJ. 2002. Environmental change and Antarctic seabird populations. *Science* **297**: 1510-1514.
- 20 Dambacher JM, Ramos-Jiliberto R. 2007. Understanding and predicting effects of modified interactions through a qualitative analysis of community structure. *The Quarterly Review of Biology* **82**: 227-250.
- 21 Ducklow HW, Baker K, Martinson DG, Quetin LB, Ross RM, Smith RC, Stammerjohn SE, Vernet M, Fraser W. 2007. Marine pelagic ecosystems: the West Antarctic Peninsula. *Philosophical Transactions of the Royal Society B-Biological Sciences* **362**: 67-94.
- 22 Duhamel G. 1998. The pelagic fish community of the polar frontal zone off the Kerguelen Islands. In: Gd Prisco, E Pisano, A Clarke eds.), *Fishes of Antarctica: A biological overview*. Springer, Milan, pp. 63-74.
- 23 Duhamel G, Gasco N, Davaine P. 2005. *Poissons des îles Kerguelen et Crozet. Guide régionale de l'océan Austral*. Muséum national d'Histoire naturelle, Paris. 419 pp.
- 24 Duhamel G, Koubbi P, Ravier C. 2000. Day and night mesopelagic fish assemblages off the Kerguelen Islands (Southern Ocean). *Polar Biology* **23**: 106-112.
- 25 Emmerson L, Southwell C. 2008. Sea ice cover and its influence on Adélie penguin reproductive performance. *Ecology* **89**: 2096-2102.
- 26 Forcada J, Malone D, Royle JA, Staniland IJ. 2009. Modelling predation by transient leopard seals for an ecosystem-based management of Southern Ocean fisheries. *Ecological Modelling* **220**: 1513-1521.
- 27 Forcada J, Trathan PN. 2009. Penguin responses to climate change in the Southern Ocean. *Global change Biology* **15**: 1618-1630.
- 28 Gouretski VV, Koltermann KP. 2004. *WOCE Global Hydrographic Climatology.. Technical Report*. Berichte des Bundesamtes für Seeschifffahrt und Hydrographie.
- 29 Grant S, Constable A, Raymond B, Doust S. 2006. *Bioregionalisation of the Southern Ocean: Report of Experts Workshop, WWF- Australia and ACE CRC*, Hobart, September 2006. pp.
- 30 Gutt J, Sirenko BI, Smirnov IS, Arntz WE. 2004. How many macrozoobenthic species might inhabit the Antarctic shelf? *Antarctic Science* **16**: 11-16.
- 31 Hosie G. 1994. The macrozooplankton communities of the Prydz Bay region, Antarctica. In: SZ El-Sayed (ed.), *Southern Ocean Ecology, the BIOMASS perspective*. Cambridge University Press, Cambridge, pp. 93-123.
- 32 Hunt BPV, Hosie GW. 2005. Zonal structure of zooplankton communities in the Southern Ocean South of Australia: results from a 2150 km continuous plankton recorder transect. *Deep-Sea Research Part I* **52**: 1241-1271.
- 33 Hunt BPV, Pakhomov EA, Hosie GW, Siegel V, Ward P, Bernard K. 2008. Pteropods in Southern Ocean ecosystems. *Progress in Oceanography* **78**: 193-221.
- 34 Kirchman DL, Anxelu X, Moran G, Ducklow H. 2009. Microbial growth in the polar oceans - role of temperature and potential impact of climate change. *Nature Reviews - Microbiology* **7**: 451-459.
- 35 Knox GA. 2007. *Biology of the Southern Ocean 2nd ed*. CRC Press, London UK. 621 pp.
- 36 Kock K-H. 1992. *Antarctic Fish and Fisheries*. Cambridge University Press, Cambridge UK. 359 pp.
- 37 Kucera M, Rosell-Mele A, Schneider R, Wailbroeck C, Weinelt M. 2005. Multiproxy approach for the reconstruction of the glacial ocean surface (MARGO). *Quaternary Science Reviews* **24**: 813-819.

- 38 Loeb V, Siegel V, Holm-Hansen O, Hewitt R, Fraser W, Trivelpiece W, Trivelpiece S. 1997. Effects of sea-ice extent and krill or salp dominance on the Antarctic food web. *Nature* **387**: 897-900.
- 39 Longhurst AR. 2007. *Ecological geography of the sea*. Academic Press, London, UK. 542 pp.
- 40 Marr JWS. 1962. The natural history and geography of the Antarctic krill (*Euphausia superba* Dana). *Discovery Reports* **32**: 33-464.
- 41 Murphy E, Hofmann E, Cavanagh R, Johnston N. 2009. Report of the Southern Ocean food web modelling Workshop. In *Integrating Climate and Ecosystem Dynamics in the Southern Ocean*
- 42 Murphy EJ, Cavanagh RD, Johnston NM, Reid K, Hofmann EE eds.) 2007. *Integrating Climate and Ecosystem Dynamics in the Southern Ocean (ICED): A Circumpolar Ecosystem Programme - Science Plan and Implementation Strategy*. IMBER, Cambridge UK
- 43 Murphy EJ, Morris DJ, Watkins JL, Priddle J. 1988. Scales of interaction between Antarctic krill and the environment. In, D Sarharge (ed., *Antarctic Ocean and Resources Variability*. Springer-Verlag, Berlin, pp. 120-130.
- 44 Murphy EJ, Watkins JL, Trathan PN, Reid K, Meredith MP, Thorpe SE, Johnston NM, Clarke A, Tarling GA, Collins MA, Forcada J, Shreeve RS, Atkinson A, Korb R, Whitehouse MJ, Ward P, Rodhouse PG, Enderlein P, Hirst AG, Martin AR, Hill SL, Staniland IJ, Pond DW, Briggs DR, Cunningham NJ, Fleming AH. 2007. Spatial and temporal operation of the Scotia Sea ecosystem: a review of large-scale links in a krill centred food web. *Philosophical Transactions of the Royal Society B-Biological Sciences* **362**: 113-148.
- 45 Murphy EJ, Watkins JL, Trathan PN, Reid K, Meredith MP, Thorpe SE, Johnston NM, Clarke A, Tarling GA, Collins MA, Forcada J, Shreeve RS, Atkinson A, Korb R, Whitehouse MJ, Ward P, Rodhouse PG, Enderlein P, Hirst G, Martin AR, Hill SL, Staniland IJ, Pond DW, Briggs DR, Cunningham NJ, Fleming AH. 2007. Spatial and temporal operation of the Scotia Sea ecosystem: a review of large-scale links in a krill centred food web. *Philosophical Transactions of the Royal Society B* **362**: 113-148.
- 46 Nicol S. 2006. Krill, currents, and sea ice: *Euphausia superba* and its changing environment. *BioScience* **56**: 111-120.
- 47 Nicol S, Constable AJ, Pauly T. 2000. Estimates of circumpolar abundance of Antarctic krill based on recent acoustic density measurements. *CCAMLR Science* **7**: 87-99.
- 48 Nicol S, Pauly T, Bindoff NL, Wright S, Thiele D, Hosie GW, Strutton PG, Woehler E. 2000. Ocean circulation off east Antarctica affects ecosystem structure and sea-ice extent. *Nature* **406**: 504-507.
- 49 Nicol S, Worby A, Leaper R. 2008. Changes in the Antarctic sea ice ecosystem: potential effects on krill and baleen whales. *Marine and Freshwater Research* **59**: 361-382.
- 50 Nicol S, Worby A, P., Strutton PG, Trull T, W. 2005. Chapter 37. Oceanographic influences on Antarctic ecosystems: observations and insights from east Antarctica (00 to 1500E) (32,P). In, AR Robinson, KH Brink eds.), *The Sea, Volume 14*. Harvard University Press, Cambridge, MA
- 51 Pasquer B, Laruelle G, Becquevort S, Schoemann W, Goosse H, Lancelot C. 2005. Linking ocean biogeochemical cycles and ecosystem structure and function: results of the complex SWAMCO-4 model. *Journal of Sea Research* **53**: 93-108.
- 52 Paton DA, Clapham PJ. 2006. *An assessment of Southern Hemisphere humpback whale population structure and migratory interchange based on Discovery mark data.*, Intersessional Workshop for the Comprehensive Assessment of Southern Hemisphere humpback whales. Scientific Committee of the International Whaling Commission. Hobart, 3-7 April 2006 (unpublished) 15 pp.
- 53 Pinkerton MH, Bradford-Grieve JM, Hanchet SM. 2009. A Balanced Model Of The Food Web Of The Ross Sea, Antarctica. *CCAMLR Science*: in press.
- 54 Quetin LB, Ross RM, Fritsen CH, Vernet M. 2007. Ecological responses of Antarctic krill to environmental variability: can we predict the future? *Antarctic Science* **19**: 253-266.
- 55 SC-CAMLR. 2004. Annex 4, Appendix D: Report of the Workshop on plausible ecosystem models for testing approaches to krill management. In, *Report of the Twenty-third Meeting of the Scientific Committee*. Commission for the Conservation of Antarctic Marine Living Resources, Hobart, Australia, pp. 231-337
- 56 SC-CAMLR, SC-IWC. 2008. Report of the CCAMLR-IWC Workshop to review input data for Antarctic marine ecosystem models. In, *Report of the Twenty-seventh Meeting of the Scientific Committee*. Commission for the Conservation of Antarctic Marine Living Resources, Hobart, Australia, pp. .
- 57 Shirihai H. 2007. *A Complete Guide to Antarctic Wildlife. 2nd edition*. Christopher Helm, London. 510 pp.
- 58 Shreeve RS, Collins MA, Tarling GA, Main CE, Ward P, Johnston NM. 2009. Feeding ecology of myctophid fishes in the northern Scotia Sea. *Marine Ecology Progress Series* **386**: 221-236.
- 59 Smith WO, Ainley DG, Cattaneo-Vietti R. 2007. Trophic interactions within the Ross Sea continental shelf ecosystem. *Philosophical Transactions of the Royal Society B-Biological Sciences* **362**: 95-111.
- 60 Trathan PN, Forcada J, Murphy EJ. 2007. Environmental forcing and Southern Ocean marine predator populations: effects of climate change and variability. *Philosophical Transactions of the Royal Society B- Biological Sciences* **362**: 2351-2365.
- 61 Treguer P, Jacques G. 1992. Dynamics of nutrients and phytoplankton, and fluxes of carbon, nitrogen and silicon in the Antarctic Ocean. *Polar Biology* **12**: 149-162.
- 62 Weimerskirch H, Inchausti P, Guinet C, Barbraud C. 2003. Trends in bird and seal populations as indicators of a system shift in the Southern Ocean. *Antarctic Science* **15**: 249-256.
- 63 Wienecke BC, Lawless R, Rodary D, Bost C-A, Thomson R, Pauly T, Robertson G, Kerry KR, LeMaho Y. 2000. Adelie penguin foraging behaviour and krill abundance along the Wilkes and Adelie Land coasts, Antarctica. *Deep Sea Research Part II. "BROKE": a multidisciplinary survey of the waters of east Antarctica (80 - 150°E)* **47**: 2573-2587.
- 64 Wienecke BC, Robertson G, Kirkwood R, Lawton K. 2007. Extreme dives by free-ranging emperor penguins. *Polar Biology* **30**: 133-142.
- 65 Williams D. 2004. Conceptual model of Antarctic epi- and mesopelagic fish. *Submission to SC-CAMLR WG-EMM*: 9pp.
- 66 Williams R, Hunt BPV, Davenport SR, Lamb T. in prep. Zooplankton and nekton community structure and biological interactions in predator feeding areas around Heard and McDonald Islands, southern Indian Ocean.

4. Current Status, Variability And Change

- 1 Arrigo KR, van Dijken GL, Bushinsky S. 2008. Primary production in the Southern Ocean, 1997–2006. *Journal of Geophysical Research* **113**: C08004.
- 2 Atkinson A, Siegel V, Pakhomov E, Rothery P. 2004. Long-term decline in krill stock and increase in salps within the Southern Ocean. *Nature* **2996**: 1-4.
- 3 Barbraud C, Weimerskirch H. 2006. Antarctic birds breed later in response to climate change. *Proceedings of the National Academy of Sciences of the United States of America* **103**: 6248-6251.
- 4 Bindoff NL, Willebrand J, Artale V, Cazenave A, Gregory J, Gulev S, Hanawa K, Quere CL, Levitus S, Nojiri Y, Shum CK, Talley LD, Unnikrishnan A. 2007. Observations: Oceanic climate change and sea level. In, S Solomon, D Qin, M Manning, Z Chen, M Marquis, et al eds.), *Climate Change 2007: the physical science basis. Contribution of Working Group I to the Fourth Assessment Report of the Intergovernmental Panel on Climate Change*. Cambridge University Press, Cambridge UK, pp. 385-432.
- 5 Boyd PW. 2002. Environmental factors controlling phytoplankton processes in the Southern Ocean. *Journal of Phycology* **38**: 844-861.
- 6 Boyd PW, Doney SC, Strzepek R, Dusenberry J, Lindsay K, Fung I. 2008. Climate-mediated changes to mixed-layer properties in the Southern Ocean: assessing the phytoplankton response. *Biogeosciences* **5**: 847-864.
- 7 Clarke A, Murphy EJ, Meredith MP, King JC, Peck LS, Barnes DKA, Smith RC. 2007. Climate change and the marine ecosystem of the western Antarctic Peninsula. *Philosophical Transactions of the Royal Society B-Biological Sciences* **362**: 149-166.
- 8 Constable AJ, Nicol S, Strutton PG. 2003. Southern Ocean productivity in relation to spatial and temporal variation in the physical environment. *Journal of Geophysical Research* **108**: 1-10.
- 9 Croxall JP, Trathan PN, Murphy EJ. 2002. Environmental change and Antarctic seabird populations. *Science* **297**: 1510-1514.
- 10 Curran MAJ, Ommen TDv, Morgan VI, Phillips VL, Palmer AS. 2003. Ice core evidence for sea ice decline since the 1950s. *Science* **302**: 1203-1206.
- 11 de la Mare WK. 1997. Abrupt mid-twentieth-century decline in Antarctic sea-ice extent from whaling records. *Nature* **389**: 57-60.
- 12 de la Mare WK. 2009. Changes in Antarctic sea-ice extent from direct historical observations and whaling records. *Climate change* **92**: 461-493.
- 13 Dinniman MS, Klinck JM. 2004. A model study of circulation and cross-shelf exchange on the west Antarctic Peninsula continental shelf. *Deep-Sea Research II* **51**: 2003-2022.
- 14 Ducklow HW, Baker K, Martinson DG, Quetin LB, Ross RM, Smith RC, Stammerjohn SE, Vernet M, Fraser W. 2007. Marine pelagic ecosystems: the West Antarctic Peninsula. *Philosophical Transactions of the Royal Society B-Biological Sciences* **362**: 67-94.
- 15 Emmerson L, Southwell C. 2008. Sea ice cover and its influence on Adélie penguin reproductive performance. *Ecology* **89**: 2096-2102.
- 16 Gille ST. 2002. Warming of the Southern Ocean since the 1950s. *Science* **295**: 1275-1277.
- 17 Gille ST. 2003. Float observations of the Southern Ocean. Part 1: Estimating mean fields, bottom velocities, and topographic steering. *J. Phys. Oceanogr* **33**: 1167-1181.
- 18 Gille ST. 2008. Decadal-scale temperature trends in the Southern Hemisphere Ocean. *Journal of Climate* **21**: 4749-4765.
- 19 Guinotte JM, Orr J, Cairns S, Freiwald A, Morgan L, George R. 2006. Will human-induced changes in seawater chemistry alter the distribution of deep-sea scleractinian corals? *Frontiers in Ecology and the Environment* **4**: 141-146.
- 20 Hughes CW, Woodworth PL, Meredith MP, Stepanov V, Ill TW, Pyne A. 2003. Coherence of Antarctic sea levels, southern hemisphere annular mode, and flow through Drake Passage. *Geophysical Research Letters* **30**: (doi:10.1029/2003GL017240).
- 21 Jenouvrier S, Barbraud C, Cazelles B, Weimerskirch H. 2005. Modelling population dynamics of seabirds: importance of the effects of climate fluctuations on breeding proportions. *Oikos* **108**: 511-522.
- 22 Jenouvrier S, Caswell H, Barbraud C, Holland M, Stroeve J, Weimerskirch H. 2009. Demographic models and IPCC climate projections predict the decline of an emperor penguin population. *Proceedings of the National Academy of Sciences of the United States of America* **106**: 1844-1847.
- 23 Jenouvrier S, Weimerskirch H, Barbraud C, Park YH, Cazelles B. 2005. Evidence of a shift in the cyclicity of Antarctic seabird dynamics linked to climate. *Proceedings of the Royal Society B-Biological Sciences* **272**: 887-895.
- 24 Jenouvrier S, Weimerskirch H, Barbraud C, Park YH, Cazelles B. 2005. Evidence of a shift in the cyclicity of Antarctic seabird dynamics linked to climate. *Proceedings of the Royal Society B* **272**: 887-895.
- 25 Lea M, Guinet C, Chérel Y, Duhamel G, Dubroca L, Pruvost P, Hindell M. 2006. Impacts of climatic anomalies on provisioning strategies of a Southern Ocean predator. *Marine Ecology Progress Series* **310**: 77-94.
- 26 Lemke P, Ren J, Alley RB, Allison I, Carrasco J, Flato G, Y. Fujii, Kaser G, Mote P, Thomas RH, Zhang T. 2007. Observations: Changes in Snow, Ice and Frozen Ground. In, S Solomon, D Qin, M Manning, Z Chen, M Marquis, et al eds.), *Climate Change 2007: The Physical Science Basis. Contribution of Working Group I to the Fourth Assessment Report of the Intergovernmental Panel on Climate Change*. Cambridge University Press, Cambridge, United Kingdom and New York, NY, USA, pp. 337-383.
- 27 Loeb V, Siegel V, Holm-Hansen O, Hewitt R, Fraser W, Trivelpiece W, Trivelpiece S. 1997. Effects of sea-ice extent and krill or salp dominance on the Antarctic food web. *Nature* **387**: 897-900.
- 28 Massom RA, O'Farrell S, Adams N, Armand L, Meiners K, Arrigo K, Curran M, Heil P, Pasquer B. In prep. Observing and modelling Antarctic sea ice habitats.
- 29 Massom RA, Stammerjohn SE, Lefebvre W, Harangozo SA, Adams N, Scambos TA, Pook MJ, Fowler C. 2008. West Antarctic Peninsula sea ice in 2005: Extreme ice compaction and ice edge retreat due to strong anomaly with respect to climate. *Journal of Geophysical Research-Oceans* **113**
- 30 McNeil BI, Matear RJ. 2008. Southern Ocean acidification: A tipping point at 450-ppm atmospheric CO₂. *Proceedings of the National Academy of Sciences of the United States of America* **105**: 18860-18864.
- 31 Meredith MP, Hogg AM. 2006. Circumpolar response of Southern Ocean eddy activity to a change in the Southern Annular Mode. *Geophysical Research Letters* **33**: doi:10.1029/2006GL026499.
- 32 Meredith MP, Murphy EJ, Hawker EJ, King JC, Wallace MI. 2008. On the interannual variability of ocean temperatures around South Georgia, Southern Ocean: Forcing by El Niño/Southern Oscillation and the Southern Annular Mode. *Deep-Sea Research Part II-Topical Studies in Oceanography* **55**: 2007-2022.
- 33 Meredith MP, Woodworth PL, Hughes CW, Stepanov V. 2004. Changes in the ocean transport through Drake Passage during the 1980s and 1990s, forced by changes in the Southern Annular Mode. *Geophysical Research Letters* **31**: L21305 (doi:10.1029/2004GL021169).
- 34 Montes-Hugo M, Doney SC, Ducklow HW, Fraser W, Martinson D, Stammerjohn SE, Schofield O. 2009. Recent Changes in Phytoplankton Communities Associated with Rapid Regional Climate Change Along the Western Antarctic Peninsula. *Science* **323**: 1470-1473.
- 35 Moy AD, Howard WR, Bray SG, Trull TW. 2009. Reduced calcification in modern Southern Ocean planktonic foraminifera. *Nature Geoscience* **2**: 276-280.

- 36 Murphy E, J., Trathan PN, Watkins JL, Reid K, Meredith MP, Forcada J, Thorpe SE, Johnston NM, Rothery P. 2007. Climatically driven fluctuations in Southern Ocean ecosystems. *Proceedings of the Royal Society of London Series B-Biological Sciences* **274**: 3057-3067.
- 37 Murphy EJ, Cavanagh RD, Johnston NM, Reid K, Hofmann EE eds.) 2007. *Integrating Climate and Ecosystem Dynamics in the Southern Ocean (ICED): A Circumpolar Ecosystem Programme - Science Plan and Implementation Strategy*. IMBER, Cambridge UK
- 38 Murphy EJ, Clarke A, Symon C, Priddle J. 1995. Temporal Variation in Antarctic Sea-Ice - Analysis of a Long-Term Fast-Ice Record from the South-Orkney Islands. *Deep-Sea Research Part I-Oceanographic Research Papers* **42**: 1045-1062.
- 39 Murphy EJ, Watkins JL, Trathan PN, Reid K, Meredith MP, Thorpe SE, Johnston NM, Clarke A, Tarling GA, Collins MA, Forcada J, Shreeve RS, Atkinson A, Korb R, Whitehouse MJ, Ward P, Rodhouse PG, Enderlein P, Hirst AG, Martin AR, Hill SL, Staniland IJ, Pond DW, Briggs DR, Cunningham NJ, Fleming AH. 2007. Spatial and temporal operation of the Scotia Sea ecosystem: a review of large-scale links in a krill centred food web. *Philosophical Transactions of the Royal Society B-Biological Sciences* **362**: 113-148.
- 40 Nicol S. 2006. Krill, currents, and sea ice: *Euphausia superba* and its changing environment. *BioScience* **56**: 111-120.
- 41 Nicol S, Robertson G. 2003. Ecological consequences of Southern Ocean harvesting. In, N Gales, M Hindell, R Kirkwood eds.), *Marine mammals: fisheries, tourism, and management issues*. CSIRO, Melbourne Aus
- 42 Nicol S, Worby A, Leaper R. 2008. Changes in the Antarctic sea ice ecosystem: potential effects on krill and baleen whales. *Marine and Freshwater Research* **59**: 361-382.
- 43 Nicol S, Worby A, P., Strutton PG, Trull T, W. 2005. Chapter 37. Oceanographic influences on Antarctic ecosystems: observations and insights from east Antarctica (00 to 1500E) (32,P). In, AR Robinson, KH Brink eds.), *The Sea, Volume 14*. Harvard University Press, Cambridge, MA
- 44 Quetin LB, Ross RM, Fritsen CH, Vernet M. 2007. Ecological responses of Antarctic krill to environmental variability: can we predict the future? *Antarctic Science* **19**: 253-266.
- 45 Riebesell U, Bellerby RGJ, Grossart HP, Thingstad F. 2008. Mesocosm CO2 perturbation studies: from organism to community level. *Biogeosciences* **5**: 1157-1164.
- 46 Riebesell U, Zondervan I, Rost B, Tortell PD, Zeebe RE, Morel FMM. 2000. Reduced calcification of marine plankton in response to increased atmospheric CO2. *Nature* **407**: 364-367.
- 47 Rintoul SR. 2007. Rapid freshening of Antarctic Bottom Water formed in the Indian and Pacific oceans. *Geophysical Research Letters* **34**: doi:10.1029/2006GL028550.
- 48 Robertson G, R.Gales eds.) 1998. *Albatross Biology and Conservation*. Surrey Beatty and Sons, Chipping Norton, Australia. 300 pp.
- 49 Sallee JB, Speer KG, Rintoul SR. 2009. Response of the Southern Ocean mixed-layer depth to climate variability. *Journal of Geophysical Research* **submitted**
- 50 SC-CAMLR, SC-IWC. 2008. Report of the CCAMLR-IWC Workshop to review input data for Antarctic marine ecosystem models. In, *Report of the Twenty-seventh Meeting of the Scientific Committee*. Commission for the Conservation of Antarctic Marine Living Resources, Hobart, Australia, pp. .
- 51 Shreeve RS, Collins MA, Tarling GA, Main CE, Ward P, Johnston NM. 2009. Feeding ecology of myctophid fishes in the northern Scotia Sea. *Marine Ecology Progress Series* **386**: 221-236.
- 52 Sokolov S, Rintoul SR. 2009. The circumpolar structure and distribution of the Antarctic Circumpolar Current fronts. Part 1: Mean circumpolar paths. *Journal of Geophysical Research* **in press**: doi:10.1029/2008JC005108.
- 53 Sokolov S, Rintoul SR. 2009. The circumpolar structure and distribution of the Antarctic Circumpolar Current fronts. Part 2: Variability and relationship to sea surface height. *Journal of Geophysical Research* **in press**: doi:10.1029/2008JC005248.
- 54 Sokolov S, Rintoul SR, Wienecke B. 2006. Tracking the Polar Front south of New Zealand using penguin dive data. *Deep-Sea Research Part I-Oceanographic Research Papers* **53**: 591-607.
- 55 Stammerjohn SE, Martinson DG, Smith RC, Iannuzzi RA. 2008. Sea ice in the western Antarctic Peninsula region: Spatio-temporal variability from ecological and climate change perspectives. *Deep-Sea Research Part II-Topical Studies in Oceanography* **55**: 2041-2058.
- 56 Stammerjohn SE, Martinson DG, Smith RC, Yuan X, Rind D. 2008. Trends in Antarctic annual sea ice retreat and advance and their relation to El Niño–Southern Oscillation and Southern Annular Mode variability. *Journal of Geophysical Research* **113**: C03S90.
- 57 Trathan PN, Forcada J, Murphy EJ. 2007. Environmental forcing and Southern Ocean marine predator populations: effects of climate change and variability. *Philosophical Transactions of the Royal Society B- Biological Sciences* **362**: 2351-2365.
- 58 Turner J, Comiso JC, Marshall GJ, Lachlan-Cope TA, Bracegirdle T, Maksym T, Meredith MP, Wang Z, Orr A. 2009. Non-annular atmospheric circulation change induced by stratospheric ozone depletion and its role in the recent increase of Antarctic sea ice extent. *Geophysical Research Letters* **36**: L08502.
- 59 Tynan CT. 1998. Ecological importance of the southern boundary of the Antarctic Circumpolar Current. *Nature* **392**: 708-710.
- 60 Weimerskirch H, Inchausti P, Guinet C, Barbraud C. 2003. Trends in bird and seal populations as indicators of a system shift in the Southern Ocean. *Antarctic Science* **15**: 249-256.

5. Assessing Climate Change Impacts

- 1 Andrewartha HG, Birch LC. 1984. *The Ecological Web: More on the Distribution and Abundance of Animals*. University of Chicago Press, Chicago
- 2 Boyd PW, Doney SC, Strzepek R, Dusenberry J, Lindsay K, Fung I. 2008. Climate-mediated changes to mixed-layer properties in the Southern Ocean: assessing the phytoplankton response. *Biogeosciences* **5**: 847-864.
- 3 Chambers LE, Hughes L, Weston MA. 2005. Climate change and its impact on Australia's avifauna. *Emu* **105**: 1-20.
- 4 Charlson RJ, Lovelock JE, Andreae MO, Warren SG. 1987. Oceanic phytoplankton, atmospheric sulphur, cloud albedo and climate. *Nature* **326**: 655-661.
- 5 Constable AJ. 2002. CCAMLR ecosystem monitoring and management: future work. *CCAMLR Science* **9**: 233-253.
- 6 Constable AJ. 2005. A possible framework in which to consider plausible models of the Antarctic marine ecosystem for evaluating krill management procedures. *CCAMLR Science* **12**: 99-117.
- 7 Dambacher JM, Gaughan DJ, Rochet M-J, Rossignol PA, Trenkel VM. 2009. Qualitative modelling and indicators of exploited ecosystems. *Fish and Fisheries* **10**: 305-322.
- 8 Dambacher JM, Ramos-Jiliberto R. 2007. Understanding and predicting effects of modified interactions through a qualitative analysis of community structure. *The Quarterly Review of Biology* **82**: 227-250.
- 9 de la Mare WK, Constable AJ. 2000. Utilising data from ecosystem monitoring for managing fisheries: development of statistical summaries of indices arising from the CCAMLR Ecosystem Monitoring Program. *CCAMLR Science* **7**: 101-117.
- 10 Downes BJ, Barmuta LA, Fairweather PG, Faith DP, Keough MJ, Lake PS, Mapstone BD, Quinn GP. 2002. Monitoring ecological impacts: concepts and practice in flowing waters. Cambridge University Press, Cambridge UK. pp. 434.
- 11 Forcada J, Trathan PN. 2009. Penguin responses to climate change in the Southern Ocean. *Global change Biology* **15**: 1618-1630.
- 12 Forcada J, Trathan PN, Reid K, Murphy EJ, Croxall JP. 2006. Contrasting population changes in sympatric penguin species in association with climate warming. *Global Change Biology* **12**: 411-423.
- 13 Fulton EA, Smith ADM, Johnson CR. 2003. Effect of complexity on marine ecosystem models. *Marine Ecology Progress Series* **253**: 1-16.
- 14 Fulton EA, Smith ADM, Punt AE. 2005. Which ecological indicators can robustly detect effects of fishing? *ICES Journal of Marine Science* **62**: 540-551.
- 15 Guinotte JM, Orr J, Cairns S, Freiwald A, Morgan L, George R. 2006. Will human-induced changes in seawater chemistry alter the distribution of deep-sea scleractinian corals? *Frontiers in Ecology and the Environment* **4**: 141-146.
- 16 Harley CDG, Hughes AR, Hultgren KM, Miner BG, Sorte CJB, Thornber CS, Rodriguez LF, Tomanek L, Williams SL. 2006. The impacts of climate change in coastal marine systems *Ecology Letters* **9**: 228-241.
- 17 Hayes K, Lynne V, Dambacher J, Sharples R, Smith R. 2008. *Ecological Indicators for the Exclusive Economic Zone Waters of the South West Marine Region. Final report for the Australian Government Department of the Environment and Heritage*. CSIRO Division of Mathematics and Information Sciences, Hobart, Australia. 172 pp.
- 18 Hill SL, Murphy EJ, Reid K, Trathan PN, Constable AJ. 2006. Modelling Southern Ocean ecosystems: krill, the food-web, and the impacts of harvesting. *Biological Reviews* **81**: 581-608.
- 19 Hill SL, Watters GM, Punt AE, McAllister MK, Le Que're C, Turner J. 2007. Model uncertainty in the ecosystem approach to fisheries. *Fish and Fisheries* **8**: 315-336.
- 20 Jennings S. 2005. Size-based analyses of aquatic food webs. In, A Belgrano, UM Scharler, J Dunne, RE Ulanowicz eds.), *Aquatic food webs: an ecosystem approach*. Oxford University Press, Oxford, pp. 86-97.
- 21 Lester RE, Fairweather PG. 2008. *Review of modelling alternatives for CLLAMM futures*. CSIRO: Water for a Healthy Country National Research Flagship
- 22 Mapstone BD. 1995. Scalable decision criteria for environmental impact assessment. In, RJ Schmitt, CW Osenberg eds.), *Detecting Ecological Impacts: Concepts and Applications in Coastal Habitats*. Academic Press, San Diego
- 23 Matear RJ, Hirst AC. 2003. Long-term changes in dissolved oxygen concentrations in the ocean caused by protracted global warming. *Global Biogeochemical Cycles* **17**
- 24 Murphy E, Hofmann E, Cavanagh R, Johnston N. 2009. Report of the Southern Ocean food web modelling Workshop. In *Integrating Climate and Ecosystem Dynamics in the Southern Ocean*
- 25 Murphy EJ, Cavanagh RD, Johnston NM, Reid K, Hofmann EE eds.) 2007. *Integrating Climate and Ecosystem Dynamics in the Southern Ocean (ICED): A Circumpolar Ecosystem Programme - Science Plan and Implementation Strategy*. IMBER, Cambridge UK
- 26 Pasquer B, Laruelle G, Becquevort S, Schoemann W, Goosse H, Lancelot C. 2005. Linking ocean biogeochemical cycles and ecosystem structure and function: results of the complex SWAMCO-4 model. *Journal of Sea Research* **53**: 93-108.
- 27 Rice JC, Rochet M. 2005. A framework for selecting a suite of indicators for fisheries management. *ICES Journal of Marine Science* **62**: 516-527.
- 28 Sarmiento JL, Slater R, Barber R, Bopp L, Doney SC, Hirst AC, Kleypas J, Matear R, Mikolajewicz U, Monfray P, Soldatov V, Spall SA, Stouffer R. 2004. Response of ocean ecosystems to climate warming. *Global Biogeochemical Cycles* **18**
- 29 SC-CAMLR. 2004. Annex 4, Appendix D: Report of the Workshop on plausible ecosystem models for testing approaches to krill management. In, *Report of the Twenty-third Meeting of the Scientific Committee*. Commission for the Conservation of Antarctic Marine Living Resources, Hobart, Australia, pp. 231-337
- 30 SC-CAMLR, SC-IWC. 2008. Report of the CCAMLR-IWC Workshop to review input data for Antarctic marine ecosystem models. In, *Report of the Twenty-seventh Meeting of the Scientific Committee*. Commission for the Conservation of Antarctic Marine Living Resources, Hobart, Australia, pp. .
- 31 Trathan PN, Forcada J, Murphy EJ. 2007. Environmental forcing and Southern Ocean marine predator populations: effects of climate change and variability. *Philosophical Transactions of the Royal Society B- Biological Sciences* **362**: 2351-2365.
- 32 Vallina SM, Simó R. 2007. Strong Relationship Between DMS and the Solar Radiation Dose over the Global Surface Ocean. *Science* **315**: 506-508.

6. Design And Implementation

- 1 Agnew DJ. 1997. The CCAMLR ecosystem monitoring programme. *Antarctic Science* **9**: 235-242.
- 2 Arrigo KR, van Dijken GL, Bushinsky S. 2008. Primary production in the Southern Ocean, 1997–2006. *Journal of Geophysical Research* **113**: C08004.
- 3 Constable AJ, de la Mare WK, Agnew DJ, Everson I, Miller D. 2000. Managing fisheries to conserve the Antarctic marine ecosystem: practical implementation of the Convention on the Conservation of Antarctic Marine Living Resources (CCAMLR). *ICES Journal of Marine Science* **57**: 778-791.
- 4 de la Mare WK. 1986. Simulation studies on management procedures. *Reports of the International Whaling Commission* **36**: 429-450.
- 5 de la Mare WK. 1996. Some recent developments in the management of marine living resources. In: RB Floyd, AW Sheppard, PJD Barro eds.), *Frontiers of Ecology*. CSIRO Publishing, Melbourne, pp. 599-616.
- 6 de la Mare WK. 1998. Tiedier fisheries management requires a new MOP (management-oriented paradigm). *Reviews in Fish Biology and Fisheries* **8**: 349-356.
- 7 de la Mare WK. 1998. Tiedier fisheries management requires a new MOP (Management-orientated paradigm). *Reviews in Fish Biology and Fisheries* **8**: 349-356.
- 8 Downes BJ, Barnuta LA, Fairweather PG, Faith DP, Keough MJ, Lake PS, Mapstone BD, Quinn GP. 2002. Monitoring ecological impacts: concepts and practice in flowing waters. Cambridge University Press, Cambridge UK. pp. 434.
- 9 Ducklow HW, Baker K, Martinson DG, Quetin LB, Ross RM, Smith RC, Stammerjohn SE, Vernet M, Fraser W. 2007. Marine pelagic ecosystems: the West Antarctic Peninsula. *Philosophical Transactions of the Royal Society B-Biological Sciences* **362**: 67-94.
- 10 El-Sayed SZ. 1994. *Southern Ocean Ecology: The BIOMASS Perspective*. Cambridge University Press, Cambridge, UK. 399 pp. pp.
- 11 Hewitt RP, Low EHL. 2000. The fishery of Antarctic krill: defining an ecosystem approach to management. *Reviews in Fisheries Science* **8**: 235-298.
- 12 Hofmann EE. in press. Southern Ocean GLOBEC: research and the future. *Antarctic Science*
- 13 Kloser RJ, Ryan TE, Young JW, Lewis ME. 2009. Acoustic observations of micronekton fish on the scale of an ocean basin: potential and challenges. *ICES Journal of Marine Science* **66**: 998–1006.
- 14 Kock KH, Reid K, Croxall J, Nicol S. 2007. Fisheries in the Southern Ocean: an ecosystem approach. *Philosophical Transactions of the Royal Society B-Biological Sciences* **362**: 2333-2349.
- 15 Lester RE, Fairweather PG. 2008. *Review of modelling alternatives for CLLAMM futures*. CSIRO: Water for a Healthy Country National Research Flagship
- 16 Murphy EJ, Watkins JL, Trathan PN, Reid K, Meredith MP, Thorpe SE, Johnston NM, Clarke A, Tarling GA, Collins MA, Forcada J, Shreeve RS, Atkinson A, Korb R, Whitehouse MJ, Ward P, Rodhouse PG, Enderlein P, Hirst AG, Martin AR, Hill SL, Staniland IJ, Pond DW, Briggs DR, Cunningham NJ, Fleming AH. 2007. Spatial and temporal operation of the Scotia Sea ecosystem: a review of large-scale links in a krill centred food web. *Philosophical Transactions of the Royal Society B-Biological Sciences* **362**: 113-148.
- 17 Nicol S, Pauly T, Bindoff NL, Wright S, Thiele D, Hosie GW, Strutton PG, Woehler E. 2000. Ocean circulation off east Antarctica affects ecosystem structure and sea-ice extent. *Nature* **406**: 504-507.
- 18 Rintoul S, Speer K, Hofmann E, Sparrow M, Meredith M, Fahrbach E, Summerhayes C, Worby A, England M, Bellerby R, Bruin T, Garabato AN, Hosie G, Alverson K, Speich S, Costa D, Hall J, Hindell M, H-C.Shin, Ryabinin V, Gladyshev S, Stansfield K. 2009. *Southern Ocean Observing System (SOOS): Rationale and strategy for sustained observations of the Southern Ocean. Community White Paper submitted to OceanObs09, Venice, Italy*. SCAR/SCOR Expert Group on Oceanography and the CLIVAR/CiC/SCAR Southern Ocean Panel 33 pp.

- 19 Smith WO, Ainley DG, Cattaneo-Vietti R. 2007. Trophic interactions within the Ross Sea continental shelf ecosystem. *Philosophical Transactions of the Royal Society B-Biological Sciences* **362**: 95-111.
- 20 Watkins JL, Hewitt R, Naganobu M, Sushin V. 2004. The CCAMLR 2000 Survey: a multinational, multi-ship biological oceanography survey of the Atlantic sector of the Southern Ocean. *Deep Sea Research Part II* **51**: 1205-1213.
- 21 Weimerskirch H, Inchausti P, Guinet C, Barbraud C. 2003. Trends in bird and seal populations as indicators of a system shift in the Southern Ocean. *Antarctic Science* **15**: 249-256.

7. Establishing A Southern Ocean Sentinel

- 1 Anisimov OA, Vaughan DG, Callaghan TV, Furgal C, Marchant H, Prowse TD, Vilhjalmsson H, Walsh JE. 2007. Polar regions (Arctic and Antarctic). In: ML Parry, OF Canziani, JP Palutikof, P.Jvd Linden, CE Hanson eds.), *Climate Change 2007: Impacts, Adaptation and Vulnerability. Contribution of Working Group II to the Fourth Assessment Report of the Intergovernmental Panel on Climate Change*. Cambridge University Press, Cambridge UK, pp. 653-685.
- 2 ATCM. 2009. *Report of the Thirty-second Antarctic Treaty Consultative Meeting*, Baltimore, USA. 705 pp.
- 3 CCAMLR. 2007. *Report of the twenty sixth meeting of the Commission for the Conservation of Antarctic Marine Living Resources*. CCAMLR, Hobart. 219 pp.
- 4 CEP. 2009. Report of the Twelfth Meeting of the Committee on Environmental Protection. In: *Report of the Thirty-second Antarctic Treaty Consultative Meeting*, Baltimore, USA, pp. 87-157.
- 5 Murphy EJ, Cavanagh RD, Johnston NM, Reid K, Hofmann EE eds.) 2007. *Integrating Climate and Ecosystem Dynamics in the Southern Ocean (ICED): A Circumpolar Ecosystem Programme - Science Plan and Implementation Strategy*. IMBER, Cambridge UK
- 6 Rintoul S, Speer K, Hofmann E, Sparrow M, Meredith M, Fahrbach E, Summerhayes C, Worby A, England M, Bellerby R, Bruin T, Garabato AN, Hosie G, Alverson K, Speich S, Costa D, Hall J, Hindell M, H-C.Shin, Ryabinin V, Gladyshev S, Stansfield K. 2009. *Southern Ocean Observing System (SOOS): Rationale and strategy for sustained observations of the Southern Ocean. Community White Paper submitted to OceanObs09, Venice, Italy*. SCAR/SCOR Expert Group on Oceanography and the CLIVAR/CiC/SCAR Southern Ocean Panel 33 pp.

Acronyms and Glossary of Terms

AABW	Antarctic Bottom Water
ACC	Antarctic Circumpolar Current
ACW	Antarctic Circumpolar Wave
ASH	Aragonite Saturation Horizon
ATCM	Antarctic Treaty Consultative Meeting
CAML	Census of Antarctic Marine Life
CCAMLR	Commission for the Conservation of Antarctic Marine Living Resources
CEAMARC	Collaborative East Antarctic Marine Census
CPR	Continuous Plankton Recorder
CTD	Conductivity/Temperature/Depth
DOM	Dissolved Organic Matter
ENSO	El Niño Southern Oscillation
HNLC	High nutrient – low chlorophyll
ICED	Integrating Climate and Ecosystem Dynamics in the Southern Ocean
IPCC	Intergovernmental Panel on Climate Change
MLD	Mixed Layer Depth
NPZD	Nutrient-phytoplankton-zooplankton-detritus
PF	Polar Front
SAF	Subantarctic Front
SAM	Southern Annular Mode
SeaWiFS	Sea-viewing Wide Field-of-view Sensor Project
SIZ	Seasonal Ice Zone
SOI	Southern Oscillation Index
SOOS	Southern Ocean Observing System
SOS	Southern Ocean Sentinel
SRDL	Satellite Relay Data Logger
SST	Sea Surface Temperature
UCDW	Upper Circumpolar Deep Water
WAP	West Antarctic Peninsula
WOCE	World Ocean Circulation Experiment

Anthropogenic

Relating to or resulting from the influence of humans

Autotrophs

Self-feeding organisms that produce complex organic compounds from simple inorganic molecules using energy from light (photosynthesis) or inorganic chemical reactions. Autotrophs are producers in food webs, such as phytoplankton.

Benthic

Living on the sea floor as opposed to in the water column

Benthos

Biota living attached to or on the sea floor

Bioregionalisation (or regionalisation)

A process that aims to partition a broad spatial area into distinct spatial regions, using a range of environmental and biological information. The process results in a set of bioregions, each with relatively homogenous and predictable ecosystem properties. The properties of a given bioregion should differ from those of adjacent regions in terms of species composition as well as the attributes of its physical and ecological habitats. The term regionalisation may be used interchangeably (or sometimes to refer to an analysis undertaken using only physical data).

Empirical

Derived from experiment or observation rather than theory

Heterotrophs

Organisms that cannot synthesize their own food and are dependent on complex organic substances for nutrition. Heterotrophs are consumers in food webs.

Lysocline

The depth in the ocean below which the rate of dissolution of calcite dramatically increases (see ASH).

Meridional

Moving along a longitude meridian

Mixotrophs

Organisms that obtain nutrition by combining autotrophic and heterotrophic mechanisms.

Nekton

Pelagic organisms that are capable of swimming independently against currents and wave action.

Neritic

The oceanic zone extending from the low tide mark to the edge of the continental shelf.

Pelagic

The open water environment or oceanic zone comprising all of the water column except that associated with the coast or the sea floor.

Plankton

Microscopic plants and animals suspended in the water column that drift with the current, with little or no locomotion. Phytoplankton (photosynthetic plankton) are the autotrophic component of the plankton community and the foundation of marine food webs.

Zonal

Moving along a latitude circle

Zooplankton

Reference to an individual group of zooplankton, which are small animals living in the pelagic environment of the ocean.

Workshop Keynote Presentations And Working Groups

Keynote Speakers

Mr. John Gunn (Chief Scientist, AAD, Australia)

Opening address

Dr. Tony Press (CEO, ACE CRC, Australia)

Antarctic climate and ecosystems

Dr. Andrew Constable (ACE CRC/AAD, Australia)

Southern Ocean Sentinel – an overview

Prof. Nathan Bindoff (ACE CRC/TPAC, Australia)

Setting the Scene: the Southern Ocean's evolving state over the last three decades inferred from ocean salinity, temperature, oxygen and altimetry data

Dr. Richard Matear (CMAR, Australia)

Southern Ocean Acidification: a tipping point at 450 ppm atmospheric CO₂

Dr. Colin Southwell (AAD, Australia)

How could rates of changes in biodiversity that result from climate change be measured in the short term and monitored over longer terms?

Prof. Eugene Murphy (NERC/BAS, UK)

Changes in the Antarctic marine ecosystem

Dr. Rob Massom (ACE CRC, Australia)

Antarctic Sea Ice – Complexities and Patterns in Distribution and Properties, and Their Physical and Ecological Implications

Dr. Dirk Welsford (AAD, Australia)

Dynamics of mesopelagic species and assemblages

Dr. Graham Hosie (AAD, Australia)

Southern Ocean Continuous Plankton Recorder Survey

Dr. Henri Weimerskirch (Centre d'Etudes Biologique de Chize, France)

Long term changes in top predators in the Southern Indian Ocean and relationships with climate and human activities

Dr. Nick Gales (AMMC, Australia)

Responses of Southern Ocean whales to climate change

Dr. Steve Nicol (AAD, Australia)

Measuring change in krill abundance

Prof. Dan Costa (University of California - Santa Cruz, USA)

Measuring change in marine habitats

Dr. Martin Riddle (AAD, Australia)

Measuring change in marine benthos

Dr. Phil Trathan (BAS, UK)

Monitoring the response of marine predators to climate change

Dr. Beth Fulton (CMAR, Australia)

Practical examples on deciding how to measure change in biota

Dr. Steve Rintoul (CMAR/ACE CRC, Australia)

Can we detect, interpret and predict Southern Ocean change?

Assoc. Prof. Kevin Arrigo (Stanford University, USA)

Using remote sensing to monitor oceans and ice

Dr. Eileen Hofmann (Old Dominion University, USA)

Understanding and monitoring climate change in the Southern Ocean mesopelagic environment

Prof. Peter Fairweather (Flinders University, Australia)

Measuring change in marine ecosystems: theory and practice

Dr. Bill de la Mare (CSIRO, Australia)

Approaches for matching objectives, monitoring and decision making in the face of uncertainty?

Working Group Topics And Convenors

Workshop 1:

What changes have been observed in the physical and chemical environment that might influence marine ecosystems and are linked to changes in climate?

Facilitators: Dr. Richard Matear, Prof. Eugene Murphy

Workshop 2:

What are the characteristics of marine biota that determine their resilience or susceptibility to these changes?

Facilitators: Dr. Steve Nicol, Dr. Dirk Welsford.

Workshop 3:

What future changes to biodiversity, including species composition and ecological processes, might be expected in marine ecosystems if the environment continues to change?

Facilitator: Prof. Peter Fairweather

Workshop 4:

How could rates of changes in biodiversity that result from climate change be measured in the short term and monitored over longer terms?

Facilitators: Dr. Beth Fulton, Dr. Phil Trathan.

Workshop 5:

What are the key processes in developing an international, multidisciplinary monitoring program to ensure it is cost-effective and likely to achieve its objective?

Facilitators: Dr. Eileen Hofmann, Dr. Nadine Johnston

Workshop 6:

What research needs to be done to reduce uncertainty in IPCC-relevant projections of future climate change and its impacts?

Facilitators: Prof. Nathan Bindoff, Assoc. Prof. Kevin Arrigo



Workshop participants in front of CCAMLR Headquarters, Hobart.

Presentations on Benefits of a Southern Ocean Sentinel

Antarctic scientific community : **Dr. Nadine Johnston** (*BAS, UK*)

Nongovernmental organisations: **Dr. Tina Tin** (*WWF*)

International forums: **Dr. Denzil Miller** (*CCAMLR Executive Secretary*)

IPCC: **Prof. Nathan Bindoff** (*ACE CRC / University of Tasmania*)

Australia: **Dr. Marcus Haward** (*ACE CRC / University of Tasmania*)

Workshop Participants

Title	First name	Last name	Organisation
Mr	Simon	Allen	CMAR, Australia
Dr	Ian	Allison	ACE-CRC/AAD, Australia
Assoc. Prof.	Kevin	Arrigo	Stanford University, USA
Dr	Sophie	Bestley	CMAR, Australia
Prof	Nathan	Bindoff	ACE-CRC/ TPAC, Australia
Ms	Deborah	Bourke	AAD, Australia
Prof.	Philip	Boyd	NIWA, NZ
Dr	Steven	Candy	AAD, Australia
Mr	Wee	Cheah	ACE-CRC, Australia
Dr	Andrew	Constable	ACE-CRC/AAD, Australia
Prof.	Dan	Costa	University of California - Santa Cruz, USA
Dr	Bill	de la Mare	CSIRO, Australia
Dr	Susan	Doust	AAD, Australia
Ms	Amy	Dumbrell	Department of Climate Change, Australia
Dr	Louise	Emmerson	AAD, Australia
Prof.	Peter	Fairweather	Flinders University, Australia
Ms	Kim	Finney	AAD, Australia
Prof.	Stewart	Frusher	UTAS, Australia
Dr	Beth	Fulton	CMAR, Australia
Dr	Nick	Gales	AMMC, Australia
Ms	Maria	Garcia	Deakin University, Australia
Mr	John	Gunn	AAD, Australia
Dr	Marcus	Haward	ACE-CRC, Australia
Mr	Paul	Hedge	Marine Division, DEWHA, Australia
Dr	Juliet	Hermes	SAEON, South Africa
Ms	Anja	Hilkemeijer	ACE-CRC, Australia
Dr	Mark	Hindell	University of Tasmania, Australia
Dr	Alistair	Hobday	CMAR, Australia
Prof.	Eileen	Hofmann	Center for Coastal Physical Oceanography, Old Dominion University, USA
Dr	Graham	Hosie	AAD, Australia
Dr	Will	Howard	ACE-CRC, Australia
Dr	Nadine	Johnston	BAS, UK
Mrs	Branislava	Jovanovic	National Climate Centre, Australian Bureau of Meteorology, Australia
Dr	So	Kawaguchi	AAD, Australia
Dr	Mary-Anne	Lea	University of Tasmania, Australia

Title	First name	Last name	Organisation
Dr	Rebecca	Leaper	CERF Marine Biodiversity Hub, Australia
Mr	Marc	Lebouvier	CNRS, France
Ms	Margaret	Lindsay	AAD/ IASOS, Australia
Dr	Gilly	Llewellyn	WWF, Australia
Mr	Tom	Maggs	AAD, Australia
Mr	Chris	Marshall	Marine Division, DEWHA, Australia
Dr	Keith	Martin-Smith	AAD, Australia
Dr	Rob	Massom	ACE-CRC, Australia
Dr	Richard	Matear	CMAR, Australia
Mr	John	McKinlay	AAD, Australia
Prof	Andrew	McMinn	IASOS, Australia
Dr	Klaus	Meiners	ACE-CRC, Australia
Dr	Denzil	Miller	CCAMLR Secretariat
Dr	Pedro	Monteiro	CSIR, South Africa
Prof	Eugene	Murphy	NERC/BAS, UK
Dr	Steve	Nicol	AAD, Australia
Dr	Gretta	Pecl	TAFI, Australia
Ms	Sandra	Potter	AAD, Australia
Dr	Tony	Press	ACE-CRC, Australia
Dr	Keith	Reid	CCAMLR Secretariat
Dr	Martin	Riddle	AAD, Australia
Dr	Steve	Rintoul	CMAR/ACE-CRC, Australia
Dr	Donna	Roberts	ACE-CRC, Australia
Dr	Jill	Schwarz	NIWA, NZ
Ms	Gill	Slocum	AAD, Australia
Dr	Colin	Southwell	AAD, Australia
Mr	Darren	Southwell	AAD, Australia
Dr	Jonny	Stark	AAD, Australia
Prof.	Michael	Stoddart	AAD, Australia
Dr	Tina	Tin	WWF, France
Dr	Phil	Trathan	BAS, UK
Dr	Tom	Trull	ACE-CRC, Australia
Ms	Jess	Tyler	ACE-CRC, Australia
Mr	John	van den Hoff	AAD, Australia
Dr	Patti	Virtue	IASOS, Australia
Dr	Victoria	Wadley	AAD, Australia
Dr	Henri	Weimerskirch	CNRS - CEB Chize, France
Dr	Dirk	Welsford	AAD, Australia
Dr	Karen	Westwood	AAD, Australia
Dr	Barbara	Wienecke	AAD, Australia
Dr	David	Wilson	AAD, Australia
Dr	Simon	Wright	AAD, Australia

Copyright Permissions

Permission to reprint copyright material in the following figures was given by the publisher listed:

Figure	Copyright permission granted by (Publisher):
1.1	UNEP/GRID-Arendal
1.2	UN FAO
2.7	Journal of Geophysical Research, American Geophysical Union
2.9	Reprinted by permission from Macmillan Publishers Ltd: Nature (Chisholm SW. Oceanography – Stirring times in the Southern Ocean. Nature 407: 685-687), copyright 2000, http://www.nature.com/index.html
2.10	NASA-GSFC
2.11	NASA/ US National Snow and Ice Data Center/University of Colorado
2.12	NASA
2.13	US National Snow and Ice Data Center
2.14	Reprinted with permission of American Scientist, The Scientific Research Society
2.17	Reprinted from Continental Shelf Research Vol 25, Beaman RJ and Harris PT. Bioregionalisation of the George V Shelf, East Antarctica, copyright 2005, with permission from Elsevier
3.5	Bioscience, Copyright, American Institute of Biological Sciences
3.13	Illustrations by Brett Jarrett, copyright Christopher Helm, London
3.14	Reprinted from Journal of Sea Research Vol 53, Pasquer B, Laruelle G, Becquevort S, Schoemann W, Goosse H, Lancelot C. Linking ocean biogeochemical cycles and ecosystem structure and function: results of the complex SWAMCO-4 model), pp. 93-108, copyright 2005, with permission from Elsevier
3.17	Cambridge University Press
4.2	Reprinted from Deep Sea Research Part II: Topical Studies in Oceanography Vol 55, Meredith MP, Murphy EJ, Hawker EJ, King JC, Wallace MI. On the interannual variability of ocean temperatures around South Georgia, Southern Ocean: Forcing by El Nino/Southern Oscillation and the Southern Annular Mode. pp. 2007-2022, copyright 2008, with permission from Elsevier
4.3	Reprinted from Deep-Sea Research Part I: Oceanographic Research Papers Vol 53, Sokolov S. Rintoul SR., Wienecke B. Tracking the Polar Front south of New Zealand using penguin dive data, pp. 591-607, copyright 2006, with permission from Elsevier
4.4	Journal of Geophysical Research, American Geophysical Union
4.5	Journal of Physical Oceanography, American Meteorological Society
4.7	Journal of Climate, American Meteorological Society
4.8	CSIRO
4.9	Geophysical Research Letters, American Geophysical Union
4.10	Reprinted with permission from The American Association for the Advancement of Science, publisher of Science
4.11	Reprinted by permission from Macmillan Publishers Ltd: Nature (Atkinson A, Siegel V. Pakhomov E., Rothery P. Long-term decline in krill stock and increase in salps within the Southern Ocean. Nature 2996: 1-4), copyright 2004, http://www.nature.com/index.html
4.12	Cambridge University Press
4.14	Reprinted with permission of Frontiers in Ecology and the Environment, Ecological Society of America
4.15	Reprinted by permission from Macmillan Publishers Ltd: Nature (Riebesell U, Zondervan I, Rost B, Tortell PD, Zeebe RE, Morel FMM. Reduced calcification of marine plankton in response to increased atmospheric CO ₂ . Nature 407: 364-367), copyright 2000, http://www.nature.com/index.html

Existing International Collaboration

Integrating Climate And Ecosystem Dynamics In The Southern Ocean (ICED)

Contacts: Nadine Johnston (British Antarctic Survey), Rachel Cavanagh (ICED Coordinator), Eugene Murphy (Chair SSC) and Eileen Hofmann (SSC Member)

ICED is a new 10 year international multidisciplinary initiative launched in response to the increasing need to develop integrated circumpolar analyses of Southern Ocean climate and ecosystem dynamics. The programme has been developed in conjunction with the Scientific Committee on Oceanic Research (SCOR) and the International Geosphere-Biosphere Programme (IGBP), through joint support from the Integrated Marine Biogeochemistry and Ecosystem Research (IMBER) and Global Ocean Ecosystem Dynamics (GLOBEC) programmes. ICED is developing a coordinated circumpolar approach to better understand climate interactions in the Southern Ocean, the implications for ecosystem dynamics, the impacts on biogeochemical cycles, and the development of sustainable management procedures. ICED is an ambitious programme to address not only the significant scientific challenges of integrating Southern Ocean ecosystem, climate and biogeochemical research at a circumpolar level, but also the challenge of bringing together a multidisciplinary group of international scientists to ensure effective cooperation and communication in addressing its objectives.

For more information email the ICED coordinator (iced@bas.ac.uk) or visit www.iced.ac.uk for more information on work currently underway and how to become involved.

Southern Ocean Observing System (SOOS): Rationale And Strategy For Sustained Observations Of The Southern Ocean

Prepared by the SCAR/SCOR Expert Group on Oceanography and the CLIVAR/CLIC/SCAR Southern Ocean Panel

Contact: Steve Rintoul, CSIRO, GPO Box 1538, Hobart, Tasmania 7001 Australia, steve.rintoul@csiro.au, 61-3-6232-5393

The Southern Ocean Observing System (SOOS) is being designed to obtain the long-term measurements required to improve understanding of climate change and variability, biogeochemical cycles and the coupling between climate and marine ecosystems. The short and incomplete nature of existing time series means that the causes and consequences of observed changes are difficult to assess. Sustained, multi-disciplinary observations are required to detect, interpret and respond to change. Advances in technology and understanding mean that it is now feasible to design and implement a Southern Ocean Observing System (SOOS) to meet this need.

The need to better understand global climate change and its impacts requires a Southern Ocean Observing System that is sustained, circumpolar, from the Subtropical Front to the Antarctic continent, multi-disciplinary (physics, biogeochemistry, sea ice, biology, surface meteorology), feasible, cost-effective, integrated with the global observing system, based initially on proven technology but evolves as technology develops, integrated with a data management system built on existing structures, able to deliver observations and products to a wide range of end-users, builds on current and future research programmes.

Six key science challenges have been identified that require sustained observations to be addressed:

1. The role of the Southern Ocean in the global heat and freshwater balance
2. The stability of the Southern Ocean overturning circulation
3. The stability of the Antarctic ice sheet and its contribution to sea-level rise
4. The future of Southern Ocean carbon uptake
5. The future of Antarctic sea ice
6. Impacts of global change on Southern Ocean ecosystems

The full SOOS plan describes the combination of sustained observations needed to address each of these key science challenges.

Scientific Committee On Antarctic Research (SCAR)

Prepared by Colin Summerhayes, Executive Director, SCAR

Contact: info@scar.org

The Scientific Committee on Antarctic Research (SCAR) is capable of contributing in a number of ways to the development of a Southern Ocean Sentinel system. SCAR is an inter-disciplinary committee of the International Council for Science (ICSU). It is charged with initiating, developing and coordinating high quality international scientific research in Antarctica and the Southern Ocean, and on their roles in the Earth system. In addition to this primary scientific role, SCAR provides objective and independent scientific advice to the Antarctic Treaty Consultative Meetings (ATCM) and other organisations, and liaises with CCAMLR on issues of science and conservation affecting the management of Antarctica and the Southern Ocean.

SCAR focuses its investment in pan-Antarctic scientific activities largely beyond the capacity of any one national programme. Two SCAR flagship programmes incorporate the Southern Ocean: Antarctica in the Global Climate System (AGCS), and Evolution and Biodiversity in the Antarctic (EBA). The AGCS team recently published a review entitled "State of the Antarctic and Southern Ocean Climate (SASOCS)" (Reviews of Geophysics, January 2009), which dealt with the physics of the climate system, while the combined AGCS and EBA team are publishing a review entitled "Antarctic Climate Change and the Environment" (Antarctic Science Journal, December 2009), which deals with both the physics and the biology of the Antarctic and Southern Ocean climate system. The latter article is an expanded Executive Summary from a 550-page book of the same title, which will be published by SCAR at <http://www.scar.org/publications/occasional/acce.html> on November 30th 2009.

SCAR's work on the physics of the Southern Ocean also takes place through several smaller committees: (i) the CLIVAR/CLIC/SCAR Southern Ocean Implementation Panel, which provides advice on observing system elements; (ii) the International Programme for Antarctic Buoys (IPAB), which deploys drifting buoys in the Southern Ocean; (iii) the Antarctic Sea Ice Processes and Climate (ASPeCt) Expert Group, which has developed

a sea ice database (<http://www.aspect.aq/data.html>), and (iv) the joint SCAR/SCOR Expert Group on Oceanography, which encourages an interdisciplinary approach to Southern Ocean observations, modelling and research, and leads the Southern Ocean science community in coordinating the development of a design for a Southern Ocean Observing System (SOOS).

SCAR's work on the biological and biogeochemical aspects of the Southern Ocean is focused through the following groups: (i) the Census of Antarctic Marine Life (CAML) Expert Group, which completed 18 voyages in 2 years and is currently moving to a synthesis phase, including a barcoding programme for Southern Ocean species; (ii) the Continuous Plankton Recorder Expert Group, which draws together all of the CPR activities of different national programmes operating in the Southern Ocean; (iii) the GLOBEC Southern Ocean programme (SO-GLOBEC) on ecosystem dynamics, now coming to a close; (iv) the Integrated Climate and Ecosystem Dynamics (ICED) programme, which is spinning up to replace and expand upon SO-GLOBEC; (v) The SCAR Marine Biodiversity Information Network (SCAR-MarBIN), which established and supports a distributed system of interoperable databases and forms the Antarctic Regional Node of the (global) Ocean Biodiversity Information System; (vi) the Expert Group on Birds and Marine Mammals; and (vii) EBA's marine activities (the EBA work packages cover: evolutionary history; evolutionary adaptation; patterns of gene flow; patterns and diversity of organisms, ecosystems and habitats; and impacts of environmental change).

Commission For The Conservation Of Antarctic Marine Living Resources (CCAMLR)

Contact: CCAMLR@CCAMLR.org
(<http://www.ccamlr.org>)

CCAMLR (The Convention for the Conservation of Antarctic Marine Living Resources), which came into force in 1982, was established in response to concerns that an increase in krill catches in the Southern Ocean could have a serious effect on populations of krill and other marine life; particularly on birds, seals and fish, which mainly depend on krill for food. The aim of the Convention is to conserve marine life of the Southern Ocean, but this does not exclude harvesting carried out in a rational manner.

The CCAMLR Ecosystem Monitoring Program (CEMP) was instigated in 1986 with the intention of providing feedback monitoring for management of the krill fishery. The aims of CEMP are to: (i) detect and record significant changes in critical components of the ecosystem to serve as a basis for the conservation of Antarctic marine living resources; and (ii) distinguish between changes due to the harvesting of commercial species and changes due to environmental variability, both physical and biological. A number of CEMP sites were established around Antarctica and the Scotia Sea at which regular monitoring of performance indicators for a number of krill-consuming predators has subsequently occurred. A major finding of a review of CEMP in 2003 was that while it was possible to detect changes in the Southern Ocean ecosystem, it was not yet possible to distinguish between ecosystem changes due to harvesting of commercial species and changes due to environmental variability. Climate change is now recognised as an additional change occurring in the ecosystem that CEMP needs to distinguish from harvesting impacts. The recent establishment of small scale management units in the south-west Atlantic for spatial management of the krill fishery also places the additional expectation on CEMP to monitor at smaller spatial scales than originally envisaged. The design of CEMP may need to be reviewed in order to address these recent developments.

Ecosystem models play an important role in determining conservation and fisheries management measures in the region. CCAMLR held a series of workshops from 2002 to 2007 aimed at developing ecosystem models, and in 2008 CCAMLR held a joint workshop with the IWC to examine the biases and uncertainties of input data for those models. A related but more focussed workshop in CCAMLR in 2008 assessed the utility of existing data on predator abundance in the Antarctic Peninsula region as a first step in estimating predator demand for krill.

In addition, CCAMLR has been compiling data and knowledge to conserve marine biodiversity. It held workshops in 2005 and 2007 aimed at determining important locations for establishing a representative system of marine protected areas in the CCAMLR area.

All of these workshops have been aimed at filling gaps in the data required to underpin CCAMLR's precautionary approach to achieving the conservation of Antarctic marine living resources.

Southern Ocean Research Partnership (SORP)

In March 2009, the Southern Ocean Research Partnership (SORP) was established to enhance cetacean conservation and the delivery of non-lethal whale research to the International Whaling Commission (IWC). The objectives, research plan, and procedural framework for the partnership were developed through a Workshop attended by 50 participants representing 12 countries (Australia, Argentina, Brazil, Chile, Costa Rica, France, Italy, Mexico, New Zealand, South Africa, Uruguay and USA) and several research and environment consortiums. The SORP has been endorsed by the Scientific Committee of the IWC.

The SORP is an integrated, collaborative, non-lethal whale research consortium that aims to maximise conservation outcomes of Southern Ocean whales through an understanding of the status, health, dynamics and environmental linkages of their populations and the threats they face.

The partners will achieve this objective through:

- *A commitment to the development of novel, powerful non-lethal technologies, important ecological theory, and analyses;*
- *focusing their collective research and funding efforts on projects that link most directly to priority conservation needs, and for which a collaborative approach maximises research outcomes and funding efficiencies;*
- *maintaining an integrated and responsive relationship with the IWC Scientific Committee and its priorities;*
- *establishing strategic linkages with other relevant international research efforts and;*
- *communicating the rationale for the research, its outcomes and threats to the conservation status of Southern Ocean whales.*

The primary focus of the SORP is the large whale species managed by the IWC, including the humpback whale, blue whale (both Antarctic and pygmy forms), fin whale, Antarctic minke whale, sei whale, southern right whale, sperm whale and killer whale.

There are two overarching research themes for SORP:

- **Theme 1: Post-exploitation whale population structure, health and status.**

Work under this program will focus on developing an improved understanding of how whale populations have recovered since the cessation of commercial whaling. It will include a strategic and focused continuation and augmentation of valuable, long-term data series (such as some of those for humpback whales and southern right whales), initiate new focused data series, and address important unknowns such as how endangered fin whales (the mainstay of industrial whaling) have responded to protection.

- **Theme 2: Changing atmosphere and oceans: Southern Ocean whales and their ecosystems.**

The Southern Ocean is a diverse environment and whales utilise this habitat in regionally different ways. Populations of whales in some regions are recovering strongly, but in others they are not. Some regions are changing fast and others more slowly.

The SORP Scientific Steering Committee will oversee the work and direction of the partnership. Membership of the steering committee includes regional representation from participating governments. The Australian Marine Mammal Centre, based at the Australian Antarctic Division in Hobart, will coordinate the overall work of SORP and manage the reporting responsibilities.

Example Regional Programs

Long-Term Monitoring Studies In The Mawson Coast Region

Prepared by Louise Emmerson & Colin Southwell

Contacts: Louise Emmerson & Colin Southwell, Australian Antarctic Division, Kingston, Tasmania
(Louise.Emmerson@aad.gov.au ; Colin.Southwell@aad.gov.au)

The Australian Antarctic Division (AAD) has been undertaking long term monitoring of Adélie penguins and emperor penguins in the Mawson coast region for the past two decades.

The Adélie penguin is an indicator species for the CCAMLR Ecosystem Monitoring Program (CEMP) because it is largely dependent on krill. Data on Adélie penguin

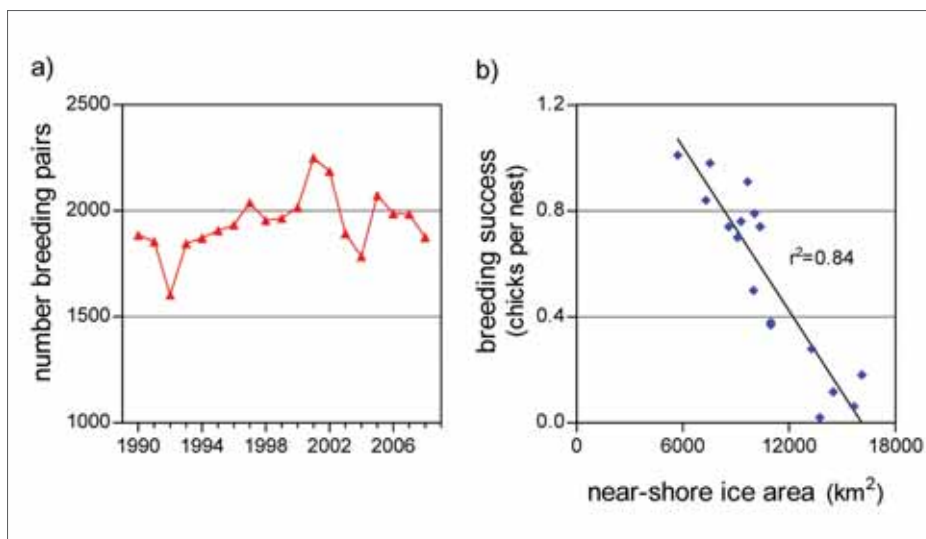

Figure 1: a) The size of the Adélie penguin breeding population at Béchervaise Island, and b) breeding success in relation to the amount of ice immediately adjacent Béchervaise Island, between 60-65°E, extending north to 66.75°S.

population and performance parameters have been collected annually at the Australian CEMP site at Béchervaise Island near Mawson station since 1990. The monitored parameters include breeding population size, breeding success, survival, foraging trip duration, diet, weight and phenology. Data are collected using standard methods developed for CEMP. More recently, alternate methods have been developed and used to collect data on population size, breeding success and phenology over a larger extent of the Mawson coastline. Statistical models have been developed to reassess historical count data to estimate long term trends in breeding population size for this and other populations.

The other species of focus in the region are emperor penguins which are the only vertebrate species that breeds during the austral winter. Currently their status, although set as “least concern” by the IUCN, is uncertain because neither the total number of colonies nor the size of their global population are known. Long-term monitoring studies of emperor penguins are rare, particularly those that include winter counts of the incubating males. At Taylor Glacier, ~90 km west of Mawson, is one of only three known emperor penguin colonies located on rock rather than sea-ice. Monitoring of this colony commenced in 1957 and was carried out intermittently

until 1987. From 1988 onward, annual counts have been conducted. Censuses are based on photographs of incubating males (June) and chicks (November/December). The work is ongoing. Efforts are underway to expand the monitoring work on emperor penguins to other colonies in the AAT.

The ultimate goal of these monitoring programs is to determine the status and trends of these two species in the AAT and to understand the underlying processes driving their population dynamics. Results indicate that in contrast to other Adélie penguin populations, there has been no overall trend in population size since the systematic monitoring program began at Béchervaise Island (Figure 1a). However, inter-annual variability is apparent in all parameters and insights into the relationships between Adélie penguins and their fluctuating environment can now be attained because the data cover a suitable time span. For example, annual variation in breeding success is strongly associated with variation in the extent of near-shore fast ice (Figure 1b) with too much fast-ice near the breeding colony being detrimental to chick rearing. By understanding how population parameters respond to the fluctuating environment, models can be developed to predict how changes in the environment will influence penguin populations.

Example references

Clarke, J., Emmerson, L.M., Townsend, A., and Kerry, K.R. (2003) Demographic characteristics of the Adélie penguin population on Béchervaise Island after 12 years of study. *CCAMLR Science* 10: 53-74.

Emmerson, L. and C. Southwell (2008). “Sea ice cover and its influence on Adélie Penguin reproductive performance.” *Ecology* 89(8): 2096-2102.

Emmerson, L.M., Clarke, J., Kerry, K.R., and Southwell, C. (2003) Temporal variability and the interrelationships between CEMP parameters collected on Adélie penguins at Béchervaise Island. *CCAMLR Science* 10: 75-90.

Long-Term Integrated Monitoring Studies At South Georgia And The South Orkney Islands

Prepared by Claire M. Waluda* and Phil N. Trathan

Contacts: British Antarctic Survey, Natural Environment Research Council, High Cross, Madingley Road, Cambridge, CB3 0ET, UK.

*E-mail: clwa@bas.ac.uk; Tel: +44 (0)1223 221 334; Fax: +44 (0)1223 221 259

The British Antarctic Survey has collected key biological parameters on the diet, breeding performance and demography of 13 marine predator species from Bird Island, South Georgia and Signy Island, South Orkneys on an annual basis since the 1970s. Currently data for a total of around 40 parameters are collected. These can be grouped into three categories: predator diet (e.g. meal mass, prey species composition, prey size structure), predator breeding performance (e.g. population size, arrival mass of adults, breeding success, provisioning rates, mass of offspring at independence) and population demography (by following the fate of individually marked animals to determine recruitment, survival and age composition of study populations). Monitoring work is undertaken on a daily basis, by staff resident year-round at Bird Island and during the summer months at Signy Island. Concurrent ship-based acoustic surveys for krill inhabiting the principal predator foraging areas to the northwest of South Georgia have been undertaken during the austral summer since 1994 on board the Royal Research Ship

James Clark Ross. These survey data are used to monitor long-term variability in krill abundance, which can in turn be related to the diet composition and performance of predator species breeding at Bird Island.

Diet data from seven species of predator have been routinely collected since 1997, with records for some species extending as far back as 1986. At Bird Island, diet data are collected for macaroni and gentoo penguins and black-browed and grey-headed albatross during the breeding season, and year-round for Antarctic fur seals. At Signy Island, diet data are obtained during the breeding season for the three resident pygoscelid species: Adélie, chinstrap and gentoo penguins. By examining long-term trends in meal mass and composition it is possible to understand what happens in years where krill are less abundant in the ecosystem, and link diet variability to the performance and productivity of each species. Environmental variability and shifts in oceanography (such as the location of the Polar Front) may cause changes in the availability of some prey species, so changes in the diet of predators can also tell us about variability in the physical environment, and may be used to help explain changes in the foraging ranges of predator species.

Comparing predator performance data with environmental data derived from long-term monitoring studies, has shown that changes in penguin, whale and fur seal population sizes are related to variability in climate and sea ice extent. In addition, the wealth of information gathered by long-term monitoring studies allows the rapid identification of extreme climate and ecosystem anomalies such as occurred at South Georgia in 2008/09. By providing baseline information derived from long-term monitoring studies it is possible to examine climate change impacts on the Scotia Sea ecosystem. Understanding predator diet, demographics and performance allows us to monitor the health of the ecosystem and provides invaluable information for food web biologists and modellers studying predator-prey interactions in the Scotia Sea ecosystem and beyond.

Finally, the information derived from our long-term monitoring studies has also alerted scientists and fisheries managers to the decline in albatross populations in the Scotia Sea, and led to the implementation of successful mitigation measures to reduce the bycatch of seabirds by fishing vessels in this region.

Example references

Croxall JP, Reid K, Prince PA (1999) Diet, provisioning and productivity responses of marine predators to differences in availability of Antarctic krill. *Mar Ecol Prog Ser* 177:115-131

Forcada J, Trathan PN (2009) Penguin responses to climate change in the Southern Ocean. *Glob Change Biol* 15:1618-1630

Forcada J, Trathan PN, Reid K, Murphy EJ (2005) The effects of global climate variability in pup production of Antarctic fur seals. *Ecology* 86:2408-2417

Forcada J, Trathan PN, Reid K, Murphy EJ, Croxall JP (2006) Contrasting population changes in sympatric penguin species in association with climate warming. *Glob Change Biol* 12:411-423

Leaper R, Cooke J, Trathan PN, Reid K, Rowntree VJ, Payne R (2006) Global climate drives southern right whale (*Eubalaena australis*) population dynamics. *Biol Lett* 2:289-292

Murphy EJ, Trathan PN, Watkins JL, Reid K, Meredith MP, Forcada J, Thorpe SE, Johnston NM, Rothery P (2007) Climatically driven fluctuations in Southern Ocean ecosystems. *Proc R Soc Lond B* 274:3057-3067

Reid K, Croxall JP, Briggs DR, Murphy EJ (2005) Antarctic ecosystem monitoring: quantifying the response of ecosystem indicators to variability in Antarctic krill. *ICES J Mar Sci* 62:366-373

Trathan PN, Murphy EJ, Forcada J, Croxall JP, Reid K, Thorpe SE (2006b) Physical forcing in the southwestern Atlantic: ecosystem control. In: Boyd IL, Wanless S, Camphuysen CJ (eds) *Top predators in marine ecosystems*. Cambridge University Press, Cambridge, p 28-45

Ross Sea Sector

Prepared by Dr Matt Pinkerton

Contact: Dr Matt Pinkerton, National Institute of Water and Atmospheric Research (NIWA), Private Bag 14901, Kilbirnie, Wellington, New Zealand. Email: m.pinkerton@niwa.co.nz; www.antarcticanz.govt.nz/science/1069.

The Ross Sea sector of the Southern Ocean (160°E–140°W) includes the Ross Sea itself, the second largest shelf-sea adjoining the Antarctic continent, as well as the Admiralty and Scott seamounts, and Balleny Islands. Selected research with potential for monitoring change in the Ross Sea sector is described below.

(1) Activities based around research stations. Three international research bases are located in the Ross Sea: Scott Base (New Zealand), McMurdo Station (USA), and Zucchelli Station (Italy). A summary of New Zealand field research is provided by Antarctica New Zealand (www.antarcticanz.govt.nz/science/1069). Information on US research in the Ross Sea is available from NSF (2009). Research on inland waters of the Ross Sea has been running since 1991, with field research carried out every summer (NIWA, Cawthron Institute New Zealand, US McMurdo Dry Valleys programme). The IceCUBE project aims to better understand the structure and functioning of benthic (seafloor) ecosystems along the Ross Sea coast and has sampled every summer since 2001/02. There is also substantial ongoing shore-based research on Antarctic demersal fishes by US, Italian and New Zealand researchers. The SW Ross Sea metapopulation of Adélie penguins has been studied for 50+ years by New Zealand and USA researchers. Ongoing research includes satellite tracking, mark-recapture and data-logging tags and censusing from aircraft photography. Weddell seal ecology in the Ross Sea has been extensively studied for 30+ years, with recent proposed increased use of aerial surveying.

(2) Fishery-related research. The longline fishery for Antarctic toothfish in the Ross Sea sector began in 1996/97 and is managed by CCAMLR. A plan for ongoing research on the biology and trophic-ecology of toothfish and by-catch species is presented by New Zealand (Ministry of Fisheries 2009). Samples of benthic invertebrates brought back from longline fishery vessels are likely to provide an opportunity for monitoring change in these biota. Pinkerton *et al.* (2009) has recently developed a balanced food-web model of the Ross Sea with which to investigate fishery and climate-related ecosystem changes.

(3) Studies using satellite remote sensing. There is substantial research underway on observing sea-ice (e.g. Stammerjohn *et al.* 2008) and phytoplankton (e.g. Arrigo & Van Dijken 2004) in the Ross Sea (and elsewhere) from Earth-observing satellite sensors.

(4) Ocean research from research vessels. The Continuous Plankton Recorder (CPR) Southern Ocean Survey has been underway since 1991, with an aim of monitoring changes in zooplankton assemblages. Although to date predominantly focussed on East Antarctica, regular CPR surveying will extend into the Ross Sea sector from 2008/09 by the annual deployment of a CPR from a New Zealand longline fishing vessel. The Ross Sea sector has been a focus for several recent research voyage programs (New Zealand IPY-CAMLR voyage, US JGOFS Antarctic Environment and Southern Ocean Process Study, AESOPS, and voyages by Italy and Japan). In particular, acoustics and nets have been used to estimate the abundance of krill and Antarctic silverfish and act as a baseline for assessing change in these crucial mid-trophic level organisms.

Example references

- Ainley, D.G., Russell, J., Jenouvrier, S., Woehler, E., Lyver, P.O'B., Fraser, W.R. and Kooyman, G.I. (2009). Antarctic penguin response to habitat change as earth's troposphere reaches 2°C above pre-industrial levels. *Ecology* (in press).
- Arrigo, K.R.; Van Dijken, G.L. (2004). Annual changes in sea-ice, chlorophyll *a*, and primary production in the Ross Sea, Antarctica. *Deep Sea Research II* 51(1-3): 117-138.
- Cummings, V. (2008). Update from IceCUBE. *Water & Atmosphere* 16(1): 4.
- Hanchet, S.M.; G.J. Rickard; J.M. Fenaughty; A. Dunn; M.J. Williams (2008) A hypothetical life cycle for Antarctic toothfish (*Dissostichus mawsoni*) in the Ross Sea region. *CCAMLR Science* 15: 35-54.
- Ministry of Fisheries (2009). New Zealand Antarctic Fisheries Medium Term Research Plan. MFish, Wellington, New Zealand. Pp 70.) New Zealand Antarctic Fisheries Medium Term Research Plan. MFish, Wellington, New Zealand. Pp 70.
- NSF (2009). National Science Foundation Office of Polar Programs, Antarctic Research. Information available at www.nsf.gov/funding/pgm_summ.jsp?pims_id=5519&org=ANT
- Pinkerton, M.H.; J.M. Bradford-Grieve; S.M. Hanchet (2009). A balanced model of the food web of the Ross Sea, Antarctica. *CCAMLR Science* (in press).
- Schreer, J.F.; Testa, J.W. (1992). Population ecology of Weddell seals in McMurdo Sound. *Antarctic Journal of the United States* 27(5): 152.
- Siniff, D.B.; R. A. Garrott; J.J. Rotella; W.R. Fraser; D.G. Ainley (2008). Projecting the effects of environmental change on Antarctic seals. *Antarctic Science* 20 (5): 425-435.
- Stammerjohn, S.E.; D.G. Martinson; R.C. Smith; X. Yuan; D. Rind (2008). Trends in Antarctic annual sea ice retreat and advance and their relation to El Niño-Southern Oscillation and Southern Annular Mode variability. *J. Geophys. Res.*, 113 (C3), C03S90, doi:10.1029/2007JC004269.

Project, Programme And Organisation Glossary

Glossary updated from the ICED web site (<http://www.iced.ac.uk>).

Symbols used in the table:

■ Member of ICED-IPY consortium 'Ecosystems and Biogeochemistry of the Southern Ocean'

○ IPY project linked through ICED-IPY

‡ Other IPY project relevant to ICED

AAD	Australian Antarctic Division
ACE	Antarctic Climate and Ecosystems Cooperative Research Centre
‡ AMES	Integrated Circumpolar Studies of Antarctic Marine Ecosystems (an IPY project)
‡ ANDEEP-SYSTCO	Antarctic benthic deep-sea biodiversity: colonisation history and recent community (an IPY project)
○ Antarctic Sea Ice	Antarctic Sea Ice in IPY Links with this Consortium will be made primarily through BASICS. Leader: Stephen Ackley. Email: sackley@pol.net Web: http://www.aspect.aq/
○ Arctic and Antarctic Sea Levels	Arctic and Antarctic Sea Level Network Development and Studies of Polar Sea Level Variability. Leader: Philip Woodworth. Email: plw@pol.ac.uk
ASAIID	Antarctic Surface Accumulation and Ice Discharge (an IPY project)
ASPeCt	Antarctic Sea Ice Processes and Climate
■ ATOS	Atmospheric inputs of organic carbon and pollutants to the polar ocean: rates, significance and outlook: a Spanish component of the OASIS programme: Leader: Carlos Duarte, IMEDEA, CSIC, Spain Aims: To investigate the role of air-sea exchanges of materials in the polar oceans by determining: (1) atmospheric inputs of organic carbon and key organic pollutants; (2) role of sea ice cover in controlling these rates and the inputs associated with sea ice melting; (3) fate of these material through food webs; and (4) effects on microplankton as the entry points of the materials in the food web. Email: carlosduarte@imedea.uib.es Web: http://www.oasishome.net/ Proposal: http://classic.ipy.org/development/eoi/details.php?id=147
AWI	Alfred Wegener Institute, Germany
BAS	British Antarctic Survey, UK
■ BASICS	Biogeochemistry of Antarctic Sea Ice and the Climate System Leader: Jean-Louis Tison, Universite Libre de Bruxelles, Belgium Aims: Year-round study of Antarctic sea ice physics and biogeochemistry to budget the exchanges of energy and matter across ocean-sea ice-atmosphere interfaces. This will help quantify impacts on fluxes of climatically important gases (CO ₂ , DMS) and carbon export to the deep ocean. Email: jtison@ulb.ac.be Web: http://www.utsa.edu/lrsg/Antarctica/SIMBA Proposal: http://classic.ipy.org/development/eoi/details.php?id=862
BIAC-IPY	Bipolar Atlantic Thermohaline Circulation-an IPY project
BIOMASS	Biological Investigation of Marine Antarctic Species and Stocks
■ BONUS-GOODHOPE	Biogeochemistry of the Southern Ocean: interactions Between NUtrients, dynamics, and ecosystem Structure Leaders: Marie Boye/Sabrina Speich, Technopole Brest-Iroise, France Aims: To carry out multidisciplinary oceanographic research at the intersection of GEOTRACES and Chokepoints/GOODHOPE. It will integrate and extend observations by GOODHOPE and will focus on the subduction zone of the Mode Waters and on the African continental margin. Email: marie.boye@univ-brest.fr or sabrina.speich@univ-brest.fr Web: http://www.univ-brest.fr/UEM/BONUS/ Proposal: http://classic.ipy.org/development/eoi/details.php?id=584
■ CaCO ₃ -IPY	The potential decline in rates of CaCO ₃ accretion and primary productivity in cold waters due to elevated CO ₂ content Leader: John Runcie, University of Sydney, Australia Aims: To study the impacts of elevated CO ₂ concentration on marine algae, in particular the extent to which elevated CO ₂ levels influence rates of carbonate accretion and oxygen evolution (~carbon fixation, photosynthesis) in relation to water depth. This project will develop predictions for the response of primary producers in Polar Regions to elevated CO ₂ under future CO ₂ scenarios. Email: jruncie@usyd.edu.au Proposal: http://classic.ipy.org/development/eoi/details.php?id=406
○ CAML	Census of Antarctic Marine Life-to be conducted under the auspices of the international Census of Marine Life. Leader: Michael Stoddart. Email: michael.stoddart@aad.gov.au Web: http://www.caml.aq/news/
○ CASO	Climate of Antarctica and the Southern Ocean-Role of Antarctica and the Southern Ocean in Past, Present and Future Climate: a strategy for the International Polar Year 2007/08 Links with this Consortium will be made primarily through SOSA. Leader: Steve Rintoul Email: Steve.Rintoul@csiro.au Web: http://www.clivar.org/organization/southern/CASO/about.htm
CCAMLR	Commission for the Conservation of Antarctic Marine Living Resources
○ CCAMLR 2008 Survey	International CCAMLR 2008 synoptic survey of krill, pelagic fish and plankton biomass and biodiversity in the South Atlantic (Area 48). Leader: Volker Siegel Email: volker.siegel@ish.bfa-fisch.de
CEMP	Ecosystem Monitoring Program
‡ Circumpolar Population Monitoring	Circumpolar monitoring of the biology of key species in relation to environmental changes
ClIC	Climate and Cryosphere
‡ ClIC-OPEN	Impact of climate-induced glacial melting on marine and terrestrial coastal Antarctic communities.
■ CLIMANT	CLIMate change in ANtArctica: A pelagic-benthic coupling approach to the extremes of the Weddell Sea Leader: Enrique Isla, Instituto de Ciencias del Mar CSIC, Spain Aims: To study aspects of climate change in Antarctica through a pelagic-benthic coupling approach to studying the extremes of the Weddell Sea. Email: isla@cmima.csic.es Web: http://www.recercaenaccio.cat Proposal: http://classic.ipy.org/development/eoi/proposal-details.php?id=232
CLIVAR	Climate Variability and Predictability
CoML	Census of Marine Life
CS-EASIZ	Coastal and Shelf Ecology of the Antarctic Sea-Ice Zone
CSIC	Consejo Superior de Investigaciones Cientificas, Spain
‡ EBA	Evolution and Biodiversity in the Antarctic: The Response of Life to Change
ECMWF	European Centre for Medium Range Weather Forecasts
EPOS	European Polarstern Study
EUR-OCEANS	European Network of Excellence for Ocean Ecosystems Analysis
○ GEOTRACES	A collaborative multi-national programme to investigate the global marine biogeochemical cycles of trace elements and their isotopes Links with this Consortium will be made primarily through Effects of CO ₂ on CaCO ₃ accretion and primary productivity, ATOS and BONUS-GOODHOPE. Leader: Hein de Baar Email: debaar@nioz.nl Web: http://www.ldeo.columbia.edu/res/pi/geotraces/

GLOBEC	Global Ocean Ecosystem Dynamics
GLOBEC-ESSAS	Ecosystem Studies of Sub-Arctic Seas
GCP	Global Carbon Project
GRACE (Ice and snow mass change)	Ice and snow mass change of Arctic and Antarctic polar regions using GRACE satellite gravimetry (an IPY project)
iAnZone	International Antarctic Zone Program
ICED	Integrating Climate and Ecosystem Dynamics in the Southern Ocean
ICED-IPY	Integrating Climate and Ecosystem Dynamics in the Southern Ocean-International Polar Year
IGBP	International Geosphere-Biosphere Programme
IMAGES	International Marine Past Global Changes Study
IMBER	Integrated Marine Biogeochemistry and Ecosystem Research
IMEDEA	Mediterranean Institute for Advanced Studies, Spain
IOCCP	International Carbon Coordination Project
IPCC	Intergovernmental Panel on Climate Change
IPY	International Polar Year
ISOS	International Southern Ocean Studies program
IWC	International Whaling Commission
IWC IDCR	International Whaling Commission's International Decade of Cetacean Research
IWC SOC	International Whaling Commission's Southern Ocean Collaboration (IWC SOC)
IWC SOWER	International Whaling Commission's Southern Ocean Whale and Ecosystem Research (SOWER) programme
JGOFS	Joint Global Ocean Flux Study
‡ MEOP	Marine Mammal Exploration of the Oceans-Pole to Pole
NCAR	National Center for Atmospheric Research
NCEP	National Center for Environmental Prediction
NOAA	National Oceanic and Atmospheric Administration
○ OASIS-IPY	Ocean-Atmosphere-Sea Ice-Snowpack Interactions Links with this Consortium will be made primarily through ATOS and Carbon in Sea Ice. Leader: Harry Beine Email: harry108@gmail.com Web: http://www.oasishome.net/
OBIS-SEAMAP	Ocean Biogeographic Information System-Spatial Ecological Analysis of Megavertebrate Populations
OCCAM	Ocean Circulation and Climate Advanced Modelling Project
PAL	Palmer Long Term Ecological Research
ROAVERRS	Research on Atmospheric Variability and Ecosystem Response in the Ross Sea
SAHFOS	Sir Alistair Hardy Foundation for Ocean Science
■ SASIE	Study of Antarctic Sea Ice Ecosystems Leader: Igor Melnikov, P.P. Shirshov Institute of Oceanology, Russia Aims: Multidisciplinary research in the Antarctic sea ice zone to understand environmental changes in the Southern Ocean. Field observations in key pelagic and coastal regions will be undertaken to examine large-scale and long-term modes of variability. Email: migor@online.ru Proposal: http://classic.ipy.org/development/eoi/details.php?id=818
○ SASSI	Synoptic Antarctic Shelf-Slope Interactions (an IPY project from iAnZone) Leader: Karen Heywood Email: K.Heywood@uea.ac.uk Web: http://roughly.tamu.edu/sassi/sassi.html
■ SCACE	Synoptic Circum-Antarctic Climate and Ecosystem study Leader: Volker Strass, AWI, Germany Aims: To examine the role of the Southern Ocean in the global climate: SCACE aims at welding together a broad range of ocean science and climate disciplines in order to address currently elusive questions such as: which physical, biological and chemical processes regulate the Southern Ocean system and determine its influence on the global climate development? How sensitive are Southern Ocean processes and systems to natural climate change and anthropogenic perturbations? Email: vstrass@awi-bremerhaven.de Web: http://www.polarjahr.de/SCACE.257+M52087573ab0.0.html Proposal: http://classic.ipy.org/development/eoi/details.php?id=16
SCAR	Scientific Committee on Antarctic Research
‡ SCAR-MarBIN	Linking, Integrating and Disseminating Marine Biodiversity Information
SCOR	Scientific Committee on Oceanic Research
SOC	Southampton Oceanography Institute, UK
SO GLOBEC	Southern Ocean Global Ocean Ecosystem Dynamics
SOIREE	Southern Ocean Iron Release Experiment
SO JGOFS	Southern Ocean Joint Global Ocean Flux Study
SOLAS	Surface Ocean-Lower Atmosphere Study
SOOP	Ship Of Opportunity Program
SOOS	Southern Ocean Observing System
SOPHOCLES	Southern Ocean Physical Oceanography and Cryospheric Linkages
SORP	Southern Ocean Research Partnership
■ SOSA	Physical and biogeochemical fluxes in the Atlantic Sector of the Southern Ocean during the IPY (SOSA = Southern Ocean South Atlantic box) Leader: Brian King, SOC, UK Aims: to conduct a suite of near-synoptic physical and biogeochemical measurements in the Atlantic sector, including transient tracers and elements of the carbon system. Email: bak@noc.soton.ac.uk Proposal: http://classic.ipy.org/development/eoi/details.php?id=283
■ SOS-CLIMATE	Southern Ocean Studies for Understanding Global Climate Issues Leader: Carlos Garcia, Universidade Federal do Rio Grande, Brazil Aims: To conduct multidisciplinary oceanographic fieldwork (physics, nutrients, bio-optics, primary production, CO ₂ , DMS, etc.) in shelf and shelf-slope regions across the Polar Front from the Antarctic Peninsula region in the south to the Patagonian Shelf region in the north. Understanding of bloom dynamics in this region is needed to anticipate changes to the regional carbon budget that may occur as a result of climate change. Email: dfgar@furg.br Web: http://www.goal.ocfis.furg.br Proposal: http://classic.ipy.org/development/eoi/details.php?id=911
WCRP	World Climate Research Program
WOCE	World Ocean Circulation Experiment
WWF	World Wide Fund for Nature
○ ZERO&DRAKE	Synoptic transects of trace elements and their isotopes in the Antarctic Ocean: A contribution to the international GEOTRACES programme. Links with this Consortium will be made primarily through Effects of CO ₂ on CaCO ₃ accretion and primary productivity. Leader: Hein De Baar Email: debaar@nioz.nl

Australian Antarctic Division

Channel Highway
Kingston Tasmania 7050
AUSTRALIA

Tel: +61 3 6232 3209
Fax: +61 3 6232 3288

Australian Business Number
(ABN): 56 428 630 676

www.aad.gov.au

Antarctic Climate & Ecosystems Cooperative Research Centre

Physical address:

Centenary Building, Grosvenor Crescent
Sandy Bay Tasmania 7005

Mailing address:

ACE CRC Private Bag 80
Hobart Tasmania 7001

Tel: 03 6226 7888
Fax: 03 6226 2440

Australian Business Number
(ABN): 38 579 689 445

www.acecrc.org.au

WWF - Australia

Physical Address:

Head Office (Sydney):
Level 13, 235 Jones St
Ultimo NSW 2007

Mailing Address:

PO Box 528
Sydney NSW 2001

Toll Free (National): 1800 032 551
Phone: +61 2 9281 5515
Fax: +61 2 9281 1060

Australian Business Number
(ABN): 57 001 594 074

www.wwf.org.au

FSC certification + logo to come:

This report is printed on Mega Recycled FSC. It is made from 50% post consumer waste and is manufactured using Elemental Chlorine Free (ECF) pulps. All post-consumer recycled fibre content is Process Chlorine Free (PCF).